



Collection 2024-2025

JULY 2024 - JUNE 2025



PCB CREATION

Manufacture d'émotions

ABBREVIATIONS

Dark choc: Dark chocolate

White choc: White chocolate

Milk choc: Milk chocolate

BB: Blanc de blanc

Choc BC: White caramelised chocolate

Compound: Dark or white compound coating

BLISTERS: Thermoformed imprints to fill with chocolate

SAVOIR-FAIRE & METHOD OF USE

Discover Savoir Faire by PCB Création,
A collection of methods that you can read as a compilation
of step by step advices and tips.



Scan the QR Code and have access to technical sheets for
each category of product, to chefs' tips and tutorial videos.
Explore your online dedicated space!

PICTOGRAMS

NEW 000000

This is new

 Free of colouring

 Worldwide

The references can be exported in the
following areas:

USA, Canada, China, Japan, UAE,
Saudi Arabia, Qatar, Kuwait, Bahrain, Oman,
South Korea, Taiwan, Singapore, Hong Kong.

N/A:

The references are not exportable in the
countries mentioned after this mention.

● Azo

Azo references are indicated by a chip after
the designation.

●●● Usable chocolates

Our chocolate recommendations for an
optimal rendering.



DO YOU HAVE A TECHNICAL QUESTION?
A CREATIVE PROBLEM CONCERNING
OUR PRODUCTS ? DO YOU NEED SOME ADVICE
OR A PROFESSIONAL'S OPINION?

We provide all the experience of our pastry chef and his in-depth
knowledge of our products and relevant techniques.
You can send your request to our Customer Service
who will take pleasure in calling upon him.

Export Customer Service
+33 (0)3 88 587 336

Dear Creatives,

Dear Artisans of Gastronomy,

We are proud to present our new collection "**C'est pas Versailles ici!**" (This isn't Versailles!)

This season, we're taking you on a journey to the PCB version of Versailles: a place of pleasure, where *joie de vivre*, festive spirit and creativity come together. A hedonist Versailles, a scoff at prevailing pessimism, brilliantly staged and showcased by our guest chefs: **Julien Alvarez, Quentin Bailly, Claire Heitzler, Etienne Leroy, Florence Lesage, Gabriel Le Quang** and **Jérémy Massing**.

Once again this year, we're offering you an accessible collection, conceived and designed to allow you to express your own universe and personality, whatever your approach, tastes, needs or limitations.

As eternal optimists, we believe that it's the small details that make all the difference, and allow us to create great things. That's why, every day at the Manufacture, we do everything we can to give you the freedom to believe in your ideas, even the boldest ones, and to bring them to life to the best of your ability.

Naturally, we share your passion for gastronomy. Of course, we're proud to be with you at your customers' tables. But our ambition goes far beyond that. Because at PCB Création, we believe that sharing, laughing - LIVING! - are what unite us and bring us together as one great family of gastronomy.

So welcome to "Our Versailles"! Let yourself be enchanted by a collection where pleasure is the main course and where creation is always served with a touch of fantasy. After all, in our kingdom, there are no strict rules - just pleasure, creativity and a little bit of madness.

Wishing you a pleasurable discovery and beautiful creations!

The PCB Création team

YOU ARE THE CHEFS!

Thank you for sharing photos of your creations with our products on instagram @pcbcreation



Alexandre Thabard @alexthabard (Christmas decoration and moulds for kits) - **Diogo Lopes** @dgranjalop (074321 Mould "Grimoire") - **L'éclat chocolaterie** @leclatchocolaterie (087006 - Decorations "Love") - **Kiki Suijkerbuijk** @kikisuijkerbuijk ("Nature" decorations) - **Name Laka** @name.laka (011164 - Structure sheets, 074098 - Moulds for kits) - **La maison de la Pâtisserie** @patisseriecoms (Christmas decoration & eclair chocolate toppings)

TABLE OF CONTENTS

WHAT'S NEW?

SMALL END OF YULE LOG P. 71
DRIED FLOWERS P. 177
MARSHMALLOW MOULDS P. 209
SILICONE MOULDS FOR ENTREMETS P. 235

TIMELESS

MERINGUÉS P. 19
OPALINES P. 25
EYES & ACCESSORIES P. 145
NATURE P. 147
CLASSIC DECORATIONS P. 157
BIRTHDAY P. 173
MARSHMALLOW DECORATIONS P. 175
DECORATIONS TO SPRINKLE P. 177
STENCILS P. 193
TRANSFER SHEETS P. 197
STRUCTURE SHEETS FOR BONBON P. 207
KITS P. 209

INGREDIENTS

INGREDIUM P. 255
100 % FRUIT/PLANT POWDERS & PIECES P. 262
INCLUSIONS P. 265

TOOLS

PIPETTES & TUBES TO FILL P. 288
PASTRY MAKING STENCILS & TOOLS P. 289
THE GENERAL SUMMARY P. 292

FESTIVE THEMES

HALLOWEEN P. 27
THANKSGIVING P. 32
ADVENT P. 34
CHRISTMAS P. 41
NEW YEAR P. 65
LOVE P. 109
MOTHER & FATHER'S DAY P. 112
ASIAN COLLECTION P. 117
EASTER P. 119
MIDDLE EAST COLLECTION P. 143

TO FILL & ENTREMETS

SHELLS & HALF-SHELLS TO FILL P. 223
POMPONS & POMPONETTES P. 227
CONTAINERS P. 229
TART SHELLS MADE IN FRANCE P. 231
ENTREMETS MOULDS P. 235
STRUCTURE SHEETS FOR ENTREMETS P. 250
TRANSFER SHEETS FOR ENTREMETS P. 252
BAKING PAPER P. 253

COLOURING

UNDERSTANDING COLOUR P. 267
100 % FRUIT/PLANT POWDERS P. 269
COLORING POWDERS P. 271
COLORED COCOA BUTTERS P. 277
VELVET SPRAYS P. 283
VARNISH P. 285
DÉCOR À MODELER P. 287

DISCOVER OUR SILICONE MOULDS RANGE

PCB Création now has a specialised workshop to create your silicone moulds:

We create and shape unique silicone moulds for you in our new specialised design office where our expert team use state-of-the-art equipment. A new service developed with one goal: to make the unique accessible to you. No minimum order (from a mould to several thousand), affordable equipment costs, different processes available, adapted to your requests, and short production times (2 weeks to create your prototype and 4 to 5 additional weeks to manufacture your mould or moulds).

PCB Création silicone moulds are made in our factory in Alsace, using premium silicone, produced in Europe, with remarkable mechanical properties. It resists temperatures from -40°C to +220°C, and even more in some cases.

Our team takes all your requirements into account to provide you with a tailor-made solution perfectly adapted to your needs (moulds for logs, desserts -individual or for sharing or even moulds for chocolate, plaques, stamps, etc.).

CUSTOMIZE YOUR MOULDS!



Yule log 2023 - Maison Sève



Contact-us
to customize your
silicone moulds



Yule log 2023 - Cyril Lignac



Entremets - Easter 2024 - Tom Coll

FLOWER POWER!

Succumb to our new range of dried or freeze-dried flowers, for delicate creations in all naturalness.
Discover our rose petals of different shades, our lilac flowers, elderberry, blueberries declined
in several shades, which will elegantly enhance your creations.
Discover the whole range of pages 177 and 179.



CUSTOM MADE BY PCB CRÉATION



1138
TYPES & SHAPES
FOR CUSTOMIZABLE
PRODUCTS



DON'T PANIC, WE WON'T SHOW
YOU EVERYTHING HERE...
(SERIOUSLY, HAVE YOU SEEN THE
SIZE OF OUR CATALOGUE?)

**DISCOVER
JAMBELI**
DISCOVER OUR ORIGIN
CHOCOLATE
COUVERTURE FROM
AN ECUADORIAN FARM
ESTATE SELECTED FOR
YOU : JAMBELI!
WHAT ELSE?

MORE THAN
30 YEARS
OF EXPERTISE
AGE IS ALL IN THE MIND

WE PRODUCE ENTIRELY
IN OUR FACTORY IN ALSACE

ELSASSISCH ISCH BOMBISCH.
ALTHOUGH WE WOULDN'T MIND
SETTLING DOWN IN THE MALDIVES. BUT
WE'RE TOLD THAT IT'S NOT THE BEST
FOR CHOCOLATE.



THEY TRUST US

**Pierre Hermé,
Fabrice Gilotte,
Vincent Guerlais,
Christophe Michalak,
Patrice Chapon,
Cédric Grolet,
Franck Jouvenal,
Lilan Bonnefoi,
Marc Ducobu,
Chocolaterie Ttote,
Alain Chartier,
Chocolaterie Dufoux...**
and many many many others...

SEPTEMBER 10TH 1995

THE FIRST MADE-TO-MEASURE
PRODUCT LEAVES OUR
FACTORY

YOU NEVER FORGET YOUR FIRST TIME



BY THE WAY, WE ARE OPEN TO THE IDEA
OF A WORLD TOUR TO MEET YOU ALL!
SEND YOUR INVITATIONS TO
STUDIO@PCB-CREATION.FR

? ? ?
WHY
CUSTOMIZE



STAND OUT FROM
YOUR COMPETITORS
SIMPLY THE BEST



SIGN YOUR PRODUCTS
& BE RECOGNIZED
HELLO. IS IT ME YOU'RE LOOKING FOR?



CREATE YOUR COLLECTIONS
& CREATE EMOTION,
TAKE A WALK ON THE WILD SIDE

CHOCO AND MORE X PCB CRÉATION

ATHOUB ALNASRALLAH

1

INSPIRATION:
CRESCENT
MOON



2

MOULD
CREATION



A THERMOFORMED MOULD
FOR KIT MOON-SHAPED
WITH A BEAUTIFUL GOLD
TRANSFER SHEET.

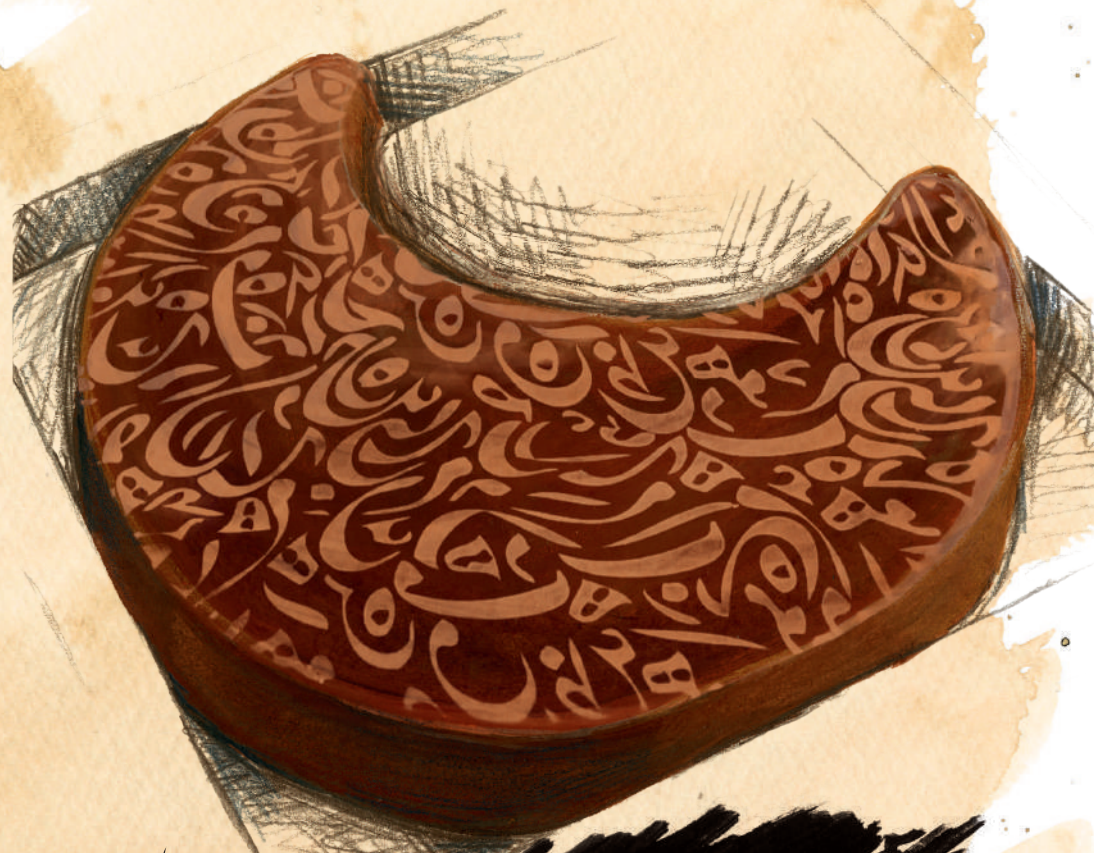

ALEXANDRE THABARD X PCB CRÉATION



THERMOFORMED
MOULDS

A BEAUTIFUL FALCON
READY TO FLY.



THERMOFORMED
MOULDS FOR
EMIRATES PALACE
MANDARIN ORIENTAL
ABU DHABI



IT'S ALMOST LIKE BEING
IN THE DESERT
WITH THIS BEAUTIFUL CAMEL.

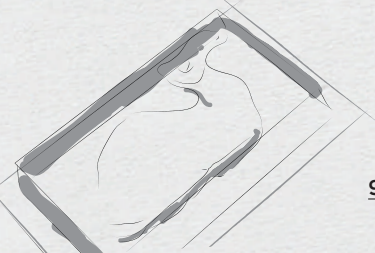
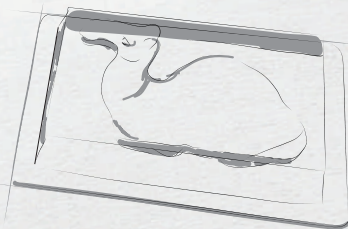

THE MAIN STEPS OF YOUR PROJECT



1

TELL US
YOUR IDEAS



2

CHOOSE YOUR
MODEL



3

CHOOSE YOUR
DESIGN



4

GET OUR
PROPOSALS

By email within 3 to 5 days

CHOOSING YOUR MODEL AND SHAPE

WHICH MODEL WOULD YOU LIKE TO PERSONALIZE?

ANY OTHER IDEAS? ALWAYS ASK, WE DON'T WANT ANY MISUNDERSTANDINGS!

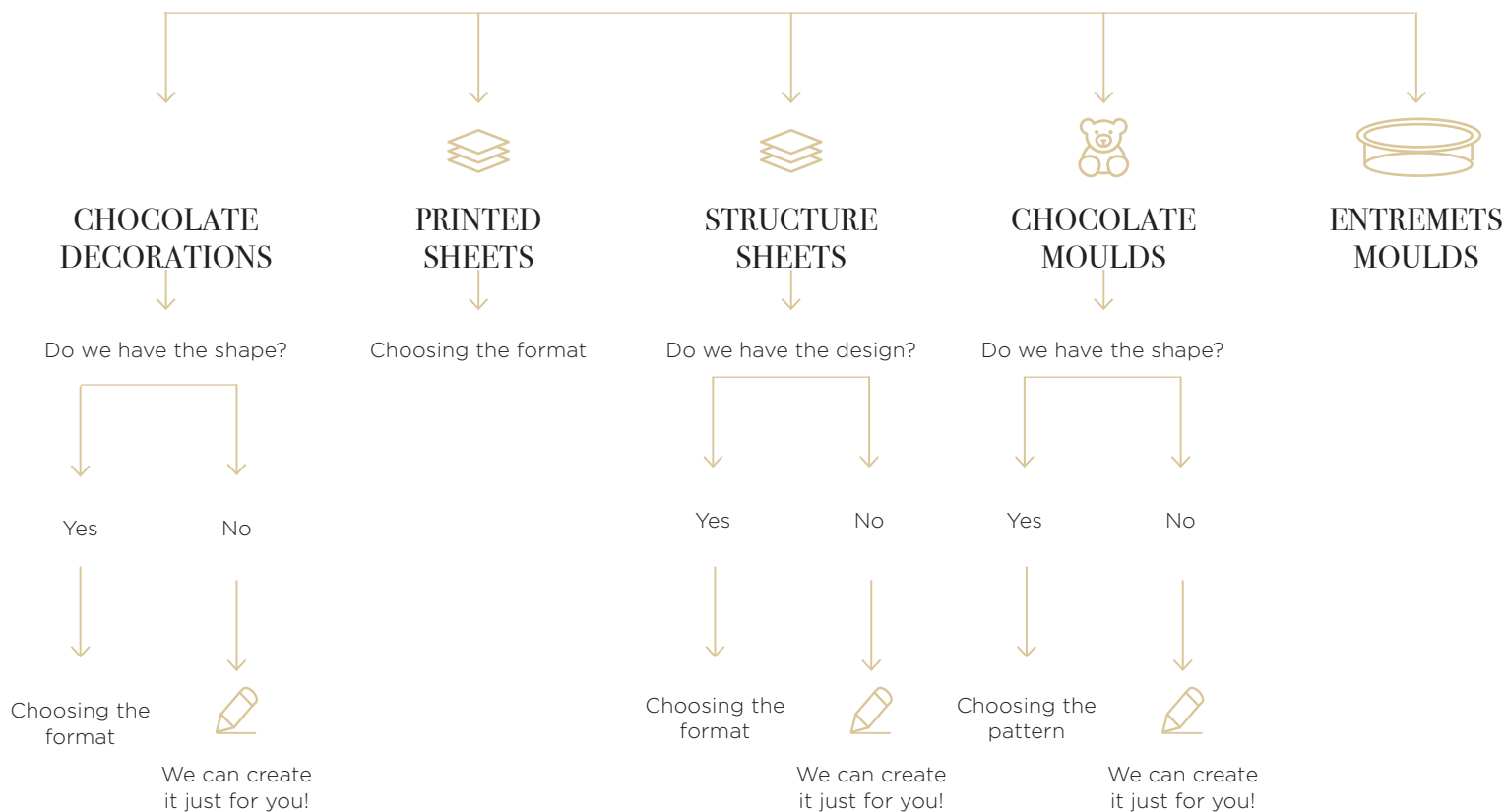

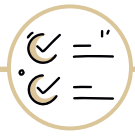

5

VALIDATE



6

RECEIVE A
PROTOTYPE

(Only upon request)



7

PRODUCTION

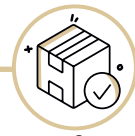

8

DELIVERY

CHOOSING THE DESIGN

WHAT DESIGN WOULD YOU LIKE?

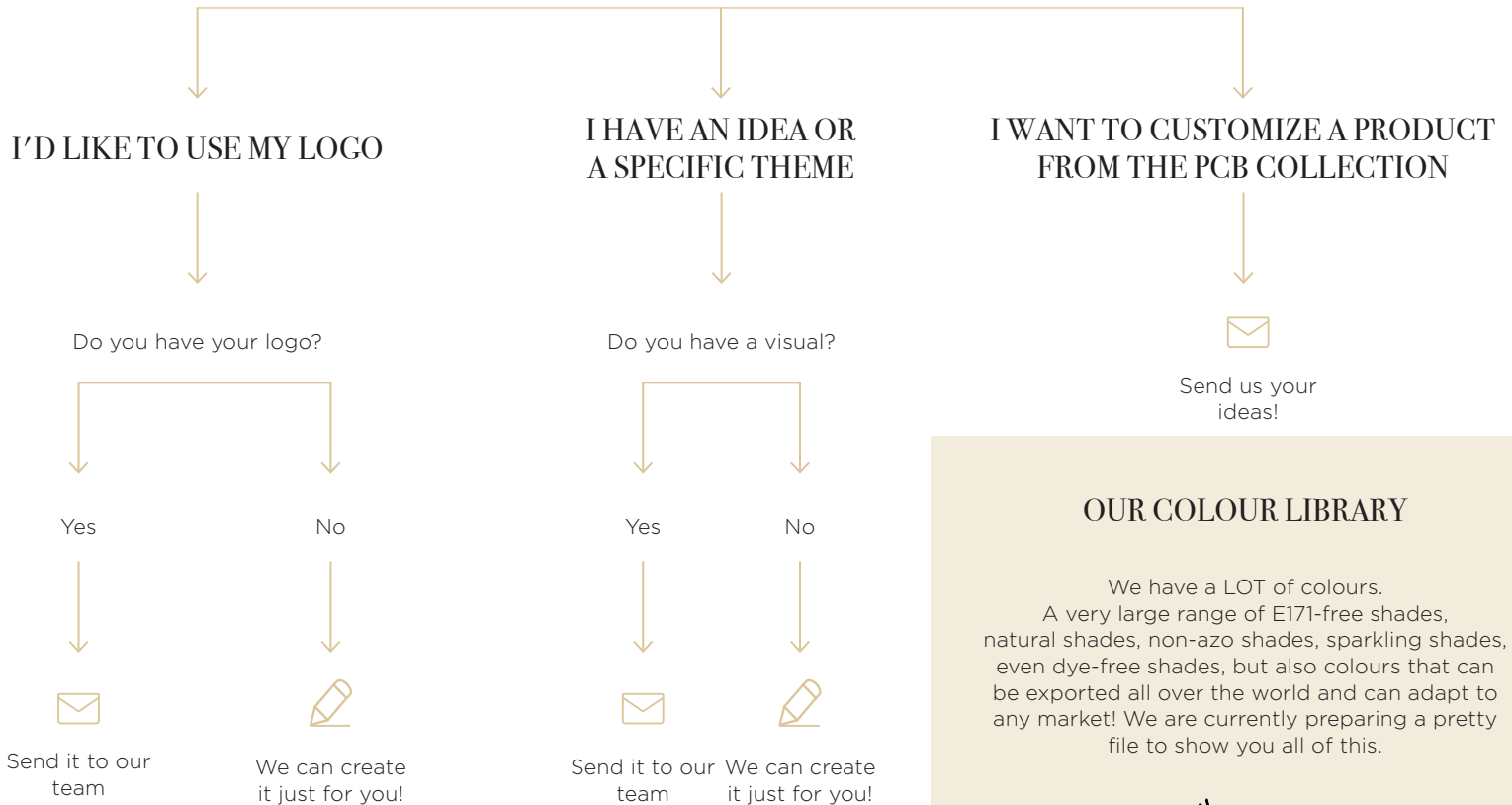

OUR COLOUR LIBRARY

We have a LOT of colours.
A very large range of E171-free shades, natural shades, non-azo shades, sparkling shades, even dye-free shades, but also colours that can be exported all over the world and can adapt to any market! We are currently preparing a pretty file to show you all of this.





SELECT A PRODUCT





CUSTOMISING MIXED CHOCOLATE DECORATIONS

As a basis for personalisation, we offer an assortment of varied shapes of plaquettes that allow you to vary your presentations.





FREE ARTWORK COSTS















MIXED CHOCOLATE PIECES - POSSIBLE IN 1 COLOUR PRINTING (GOLD) ONLY						
SHAPE	DIMENSIONS	PRINTED BLISTERS per box of 100 sheets		CHOC. PIECES MADE WITH DOSING MACHINE Minimum order per 5 boxes		
		Designs per sheet	Designs per box	Choc. pieces per sheet	Choc. pieces per box	Number of pieces per order
	Round 20 mm Square 18 mm Oval 25 x 15 mm	48 16 of each shape	4800 1600 of each shape	48 16 of each shape	960 320 of each shape	4800 1600 of each shape
	Round 30 mm Square 27 mm Oval 37 x 24 mm	27 9 of each shape	2700 900 of each shape	27 9 of each shape	540 180 of each shape	2700 900 of each shape



CUSTOMISATION OF CHOCOLATE PIECES

Many other sizes and shapes are available, please contact our team.

SHAPE	DIMENSIONS	TRANSFER SHEETS		CHOCOLATE PIECES			
		FOR STENCIL per 125 sheets	BLISTERS per 100 sheets	STENCIL CHOCOLATE PIECES Minimum of 3 boxes		CHOC. PIECES DOSING MACHINE - Minimum of 10 boxes	
		Designs per sheet	Imprints per sheet	Choc. pieces per sheet	Choc. pieces per box	Choc. pieces per sheet	Choc. pieces per box
	20 X 20 mm	24	176	24	480	176	880
	30 X 30 mm	24	88	24	480	88	440
	40 X 40 mm	12	48	12	240	48	240
	70 X 70 mm	4	24	4	80	24	120
	ø 20 mm	44	76	44	880	76	880
	ø 25 mm	24	108	24	480	108	540
	ø 30 mm	24	88	24	480	88	440
	ø 40 mm	12	48	12	240	48	240

SHAPE	DIMENSIONS	TRANSFER SHEETS		CHOCOLATE PIECES			
		FOR STENCIL per 125 sheets	BLISTERS per 100 sheets	STENCIL CHOCOLATE PIECES Minimum of 3 boxes		CHOC. PIECES DOSING MACHINE - Minimum of 10 boxes	
		Designs per sheet	Imprints per sheet	Choc. pieces per sheet	Choc. pieces per box	Choc. pieces per sheet	Choc. pieces per box
	30 X 10 mm	40	152	40	480	152	760
	40 X 29 mm	12	66	12	240	66	330
	45 X 15 mm	30	90	30	600	90	450
	50 X 7 mm	28	95	28	560	95	475
	55 X 15 mm	30	78	30	600	78	390
	60 X 40 mm	10	32	10	200	32	160
	70 X 15 mm	15	70	15	300	70	350
	70 X 20 mm	20	55	20	400	55	275
	25 X 16 mm	20	135	20	400	135	675
	34 X 17 mm	28	120	28	560	120	600
	39 X 23 mm	28	78	28	560	78	390
	42 X 30 mm	21	66	21	420	66	330
 ECLAIR	132 X 32 mm	6	-	6	120	-	-
 MINI-ECLAIR	15 X 68 mm	20	-	20	400	-	-
 HEART	30 X 27 mm	24	99	24	480	99	495
 HEART	48 X 44 mm	12	40	12	240	40	200
 BANNER	79 X 33 mm	12	33	12	240	33	165
 BISCUIT	50 X 40 mm	-	45	-	-	45	225
 LABEL	38 X 75 mm	-	30	-	-	30	150
 END OF YULE LOG	80 X 50 mm	8	21	8	160	21	105 (min.10 boxes)
 END OF YULE LOG	80 X 60 mm	4	18	4	80	18	90 (min.10 boxes)
 END OF YULE LOG	68 X 82 mm	4	15	4	80	15	75 (min.10 boxes)
 END OF YULE LOG	75 X 75 mm	-	15	-	-	15	75 (min.10 boxes)
 END OF YULE LOG	85 X 75 mm	4	-	4	80	-	-
 END OF YULE LOG	90 X 85 mm	4	-	4	80	-	-

CUSTOMISATION OF CHOCOLATE PIECES

SHAPE	DIMENSIONS	TRANSFER SHEETS		CHOCOLATE PIECES			
		FOR STENCIL per 125 sheets	BLISTERS per 100 sheets	STENCIL CHOCOLATE PIECES Minimum of 3 boxes		CHOC.PIECES DOSING MACHINE - Minimum of 10 boxes	
		Designs per sheet	Imprints per sheet	Choc. pieces per sheet	Choc. pieces per box	Choc. pieces per sheet	Choc. pieces per box
 END OF YULE LOG	90 X 90 mm	3	12	3	60	12	60 (min.10 boxes)
 EGG	64,5 X 47,5 mm	8	28	8	160	28	140 (min.10 boxes)
 STAR	30 X 30 mm	-	108	-	-	108	540 (min.10 boxes)
 STAR	45 X 45 mm	-	48	-	-	48	240 (min.10 boxes)
 STAR	61 X 61 mm	-	30	-	-	30	150 (min.10 boxes)
 STICK	138 X 5 mm	-	72	-	-	72	144 (min.25 boxes)
 SPOON	108 X 26 mm	-	24	-	-	24	120 (min.20 boxes)
 MINI-SPOON	80 X 20 mm	-	45	-	-	45	225 (min.20 boxes)
 WAX SEAL	ø 35 mm	-	63	-	-	63	315 (min.20 boxes)
 3D HALF-BALL	ø 26 mm	-	63	-	-	63	630 (min.20 boxes)
 3D HALF-EGG	34 X 23 mm	-	63	-	-	63	630 (min.20 boxes)



CUSTOMISATION OF TRANSFER SHEETS

We can cut any size your heart desires,
please contact our team!

SUPPORT	DIMENSIONS	Pieces per box	Minimum number of boxes per order
NYLON	4 X 4 cm	3000	1
	36 X 13 cm	125	1
	40 X 25 cm	125	1
	40 X 60 cm	125	1
PET	40 X 60 cm	125	1
BAKING PAPER	40 X 60 cm	125	1
MACROLON SHEETS	26,5 X 12,5 cm	125	1

Simple to use products for maximum effect, we also offer personalisation of our chocolate kits. Many other kits can be personalised, feel free to contact our team!







CUSTOMISING KITS

SHAPE	DIMENSIONS	BLISTERS AND TRANSFER SHEETS		CHOCOLATE PIECES		
		Number of pieces per blister/sheet	Number of pieces per box	Number of pieces per blister or sheet	Number of pieces per box	Minimum of boxes per order
LOLLIPOPS	ø 54 mm	5 pieces	2250 pieces	5 pieces	60 pieces	38 pieces
PUZZLES	190 X 130 mm	1 piece	450 pieces	-	-	-
HALF LIPSTICKS	52 X 12,5 mm	36 pieces	7200 pieces	36 pieces	288 pieces	13 pieces
CREDIT CARDS	85 X 55 mm	5 pieces	625 pieces	5 pieces	100 pieces	3 pieces
POSTAL CARDS	210 X 105 mm	1 piece	375 pieces	-	-	-
SQUARE CARDS	119,5 X 119,5 mm	1 piece	750 pieces	-	-	-
CD	ø 115 mm	1 piece	375 pieces	-	-	-

We offer a range of decorations (chocolate and marshmallow plaquettes) to be placed on the foam of your coffees and hot drinks, or on glasses for your cold ones. Discover our Bar range!



CUSTOMISING DRINKS

SHAPE	DIMENSIONS	MARSHMALLOW PIECES		"EXTRA-THIN" CHOCOLATE PIECES		
		Designs per box	Minimum of boxes per order	Choc. pieces per sheet	Choc. pieces per box	Number of pieces per order
	ø 30 mm	288	3	24	480	1440
	ø 40 mm	144	3	12	240	720
	25 X 25 mm	-	-	56	336	3360
	40 X 40 mm	-	-	27	162	1620

CUSTOMIZE YOUR MACAROONS!

Make your macaroons unique, thanks to this original concept developed by Thierry Atlan, Meilleur Ouvrier de France Chocolatier (Best Chocolatier in France) based in New York.

It's very simple:

We personalise the blister packs with your logo or the message of your choice.
Then all you have to do is pour your chocolate into the blister and place your macaroon shell on top...
(For easier use, the blisters are designed to be suitable for one-shot filling)

Your macaroons will then be covered in a delicate layer of personalised chocolate.



Contact-us
to customize your
blister for macaroons.



FOR A REAL EYE CATCHER:
CUSTOMIZE THEM WITH YOUR LOGO,
YOUR FAVOURITE PATTERNS,
OR WHY NOT TRY PRINTING SOME
SWEET NOTHINGS.



CONTACT US!

Receive your free print voucher and your quotation



PCB Création
1 rue de Hollande
CS 60067
67232 BENFELD CEDEX FRANCE



(33) 03 88 587 336



pcb.creation@
pcb-creation.fr



www.pcb-creation.com



"MERINGUÉS" DECORATIONS

Fall in love with our range of "Meringués" decorations, and give in to their immaculate colour! Stars, snowflakes, flowers, leaves... these essentials combine purity and delicacy: the ideal harmony to elegantly enhance your desserts.



074267
360 "Meringués" decorations embossed "Petits flocons" 3 designs 2,3 x 2,4 cm
N/A: USA, China, Japan, Hong Kong



087058
120 "Meringués" decorations "Ourson" 2,5 x 3,4 cm
N/A: USA, China, Japan, South Korea, Hong Kong

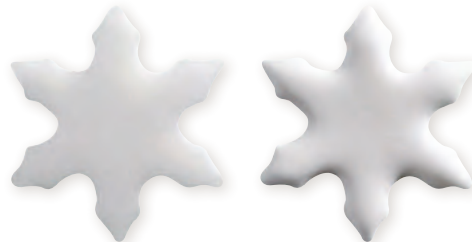

070413
270 "Meringués" decorations "Petits cristaux"
2,8 x 3,2 cm - N/A: USA, China, Japan, Hong Kong



074266
150 Crystallized "Meringués" decorations
"Flocon" 4,8 x 4,2 cm - N/A: USA, China, Japan, Hong Kong



070407
140 "Meringués" decorations embossed
"Grands cristaux" 4,35 x 5 cm - N/A: USA, China, Japan, Hong Kong



070408
270 "Meringués" decorations embossed "Petits cristaux"
2,8 x 3,2 cm - N/A: USA, China, Japan, Hong Kong



074263
500 "Meringués" decorations "Petites boules de Noël" 4 designs 1,7 x 2,4 cm
N/A: USA, China, Japan, UAE, Saudi Arabia, Qatar, Kuwait, Bahrain, Oman, South Korea, Hong Kong

DECORATIONS



074264
140 Crystallized "Meringués" decorations "Feuilles de houx" 3 designs - N/A: USA, China, Japan, Hong Kong

070411
150 "Meringués" decorations "Flocon"
4,8 x 4,2 cm - N/A: USA, China, Japan, Hong Kong



074258
120 "Meringués" decorations "Étoiles" 4 designs - N/A: USA, China, Japan, UAE, Saudi Arabia, Qatar, Kuwait, Bahrain, Oman, South Korea, Hong Kong

074265
140 Crystallized "Meringués" decorations "Feuilles de chêne" 3 designs - N/A: USA, China, Japan, Hong Kong

DECORATIONS



LIKE OUR GUEST CHEFS,
CREATE YOUR OWN CUSTOM
MERINGUE DECORATIONS!

 **070414**
180 "Meringués" decorations embossed "Feuilles" 4 designs - N/A: USA, China, Japan, Hong Kong

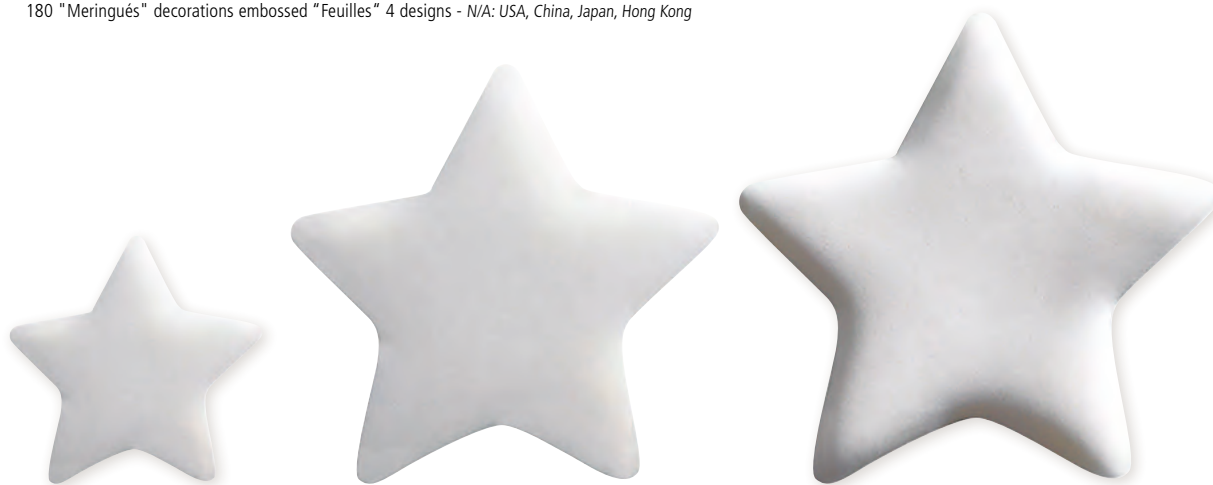

 **070410**
120 "Meringués" decorations "Étoiles" 4 designs - N/A: USA, China, Japan, Hong Kong



070418
160 "Meringués" decorations "Étoile filante" 2 designs - N/A: USA, China, Japan, UAE, Saudi Arabia, Qatar, Kuwait, Bahrain, Oman, South Korea, Hong Kong

 **070409**
120 Crystallized "Meringués" decorations "Étoiles" 4 designs - N/A: USA, China, Japan, Hong Kong



DECORATIONS



074127

120 "Meringués" decorations embossed "Grandes Fleurs" ø 4,5 cm 3 designs - N/A: USA, China, Japan, Hong Kong

074262

200 "Meringués" decorations "Ailes de papillons" 2 designs 3,2 x 4,5 cm - N/A: USA, China, Japan, UAE, Saudi Arabia, Qatar, Kuwait, Bahrain, Oman, South Korea, Hong Kong



074126

240 "Meringués" decorations embossed "Petites Fleurs" ø 3 cm 3 designs - N/A: USA, China, Japan, Hong Kong

074260

270 "Meringués" decorations "Moineaux" 2 designs - N/A: USA, China, Japan, UAE, Saudi Arabia, Qatar, Kuwait, Bahrain, Oman, South Korea, Hong Kong



074128

120 "Meringués" decorations "Fleurs de cerisier" ø 3 cm 6 designs - N/A: USA, China, Japan, UAE, Saudi Arabia, Qatar, Kuwait, Bahrain, Oman, South Korea, Hong Kong

074133

270 "Meringués" decorations "Love" 3 cm 6 designs - N/A: USA, China, Japan, Hong Kong



OPALINES

Discover the finesse and elegance of these crystal decorations.
The magic and light combined in the transparency and brilliance of Isomalt will fascinate your customers and add a ray of light to your creations.



070400
32 Opalines "Étoiles bronze" 2 designs
5,7 x 5,4 - 4,3 x 4,1 cm
N/A: USA, China, Japan, Qatar, South Korea,
Hong Kong

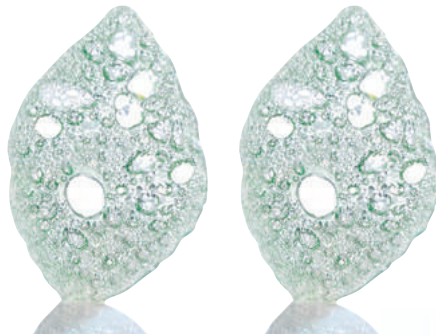

070402
64 Opalines "Feuilles de citron vert" 2,3 x 3,75 cm
N/A: USA, Canada, China, Japan, UAE, Saudi Arabia, Qatar, Kuwait,
Bahrain, Oman, South Korea, Taiwan, Hong Kong



065316
32 Opalines bronze \pm \varnothing 5 cm
N/A: USA, China, Japan, Qatar, South Korea, Hong Kong

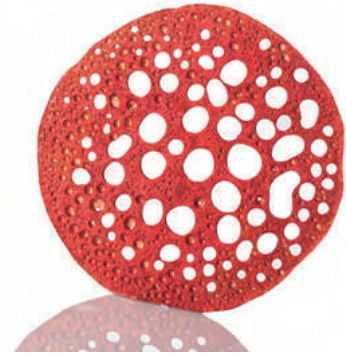

065317
32 Opalines ruby red \pm \varnothing 5 cm
N/A: USA, China, Japan, UAE, Saudi Arabia, Qatar, Kuwait,
Bahrain, Oman, South Korea, Hong Kong

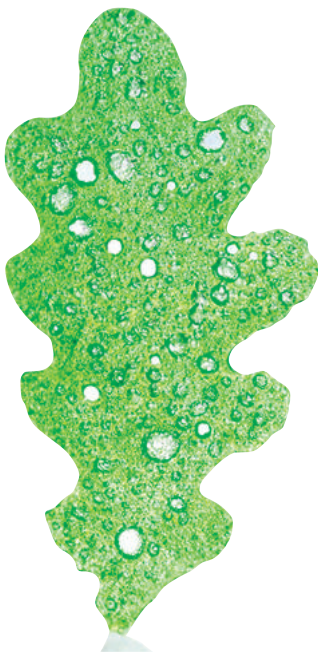

070403
32 Opalines "Feuilles de chêne vert"
7,8 x 3,9 cm - N/A: Canada, China, Japan, UAE,
Saudi Arabia, Qatar, Kuwait, Bahrain, Oman,
Hong Kong



070404
32 Opalines "Feuilles de chêne orange"
7,8 x 3,9 cm - N/A: China, Japan, Hong Kong,
Singapore



007273
32 Snowflakes crystal gold spangled \varnothing 5,5 cm
N/A: USA, China, Japan, UAE, Saudi Arabia, Qatar,
Kuwait, Bahrain, Oman, South Korea, Hong Kong



007260
32 Snowflakes crystal silver spangled \varnothing 5,5 cm
N/A: China, Japan, UAE, Saudi Arabia, Qatar, Kuwait,
Bahrain, Oman, South Korea, Hong Kong

CRYSTAL DECORATIONS



HAPPY HALLOWEEN



070346
70 Skulls Dark choc embossed
"Calavera" 3 x 4 cm



070343
130 Bats Dark choc 5 x 2,4 cm



087041
135 Pumpkins White choc "Effrayantes" 4 designs - 3 x 2,7 cm
N/A: USA, China, Japan, South Korea, Hong Kong



070355
80 Headstones Dark choc 3 designs

NEW 088219
108 Pumpkins tops orange
colored chocolate "Curcurbitacée"
4 x 3,95 cm - N/A: Canada, China,
Hong Kong



NEW 088217
154 Spiders Dark choc "Aragog" 2,9 x 3,1 cm



NEW 088220
176 Skulls White choc 3 x 2,9 cm

NEW 088221
117 Skulls Dark choc
2,4 x 2,5 cm



NEW 088222
176 Ghosts White choc "Bouh" 3 x 2,95 cm



070344
150 Knives and choppers White choc 2 designs



070354
104 Bones White choc 6 x 2,4 cm

DECORATIONS



NEW 087129

110 Decorations Compound "Pains d'épices" 2 designs 3 x 4,5 cm
N/A: China, Japan, UAE, Saudi Arabia, Qatar, Kuwait, Bahrain, Oman



070347

208 Ghosts White choc "Frère et sœurs" 3 designs



070371

126 Witch hats Dark choc "Sorcière"
3,78 x 3,6 cm • N/A: China, UAE, Saudi Arabia, Qatar, Kuwait, Bahrain, Oman



NEW 088218

140 Pumpkins Dark choc and orange colored chocolate "Jack" 4 designs
N/A: China, Japan



NEW 088100

108 Pumpkins White choc
"Happy Halloween" 4 x 3,7 cm- N/A:
China, Japan, UAE, Saudi Arabia, Qatar, Kuwait,
Bahrain, Oman, South Korea, Hong Kong



070372

176 Maneles Dark choc "Effrayant" 2,8 x 3 cm - 4 designs •
N/A: UAE, Saudi Arabia, Qatar, Kuwait, Bahrain, Oman



087036

208 Skulls Compound "Calavera" 2,25 x 3 cm - 7 designs - N/A: China, Japan, Hong Kong



NEW 088027

60 Squares White choc "Ténèbres" 4 cm
N/A: USA, China, Japan, UAE, Saudi Arabia,
Qatar, Kuwait, Bahrain, Oman, South Korea,
Hong Kong



NEW 088028

60 Squares White choc "Happy Halloween"
4 cm - N/A: USA, China, Japan, UAE, Saudi
Arabia, Qatar, Kuwait, Bahrain, Oman, South
Korea



NEW 045015

Colored cocoa butter
100% fruit/plant based
"Cacao noir" - 200 g



065295

Colored cocoa butter
natural origin
"Orange" - 200 g
N/A: China, Singapore

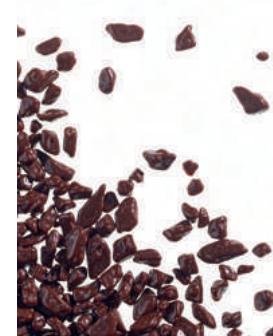

NEW 070267

Chocolate chips - 500 g

Free of colouring • Worldwide • Azo



For even more terrifying moulds, consider filling the skeleton and skull with white chocolate!



070423

9 Moulds coffin "Six pieds sous terre"
Bottom: 7,9 x 14,6 cm - Th. 3 cm - Cover:
7,9 x 14,6 cm - Th. 1,37 cm
Skeleton: 6,5 x 13,2 cm - Th. 0,8 cm



070390

9 Blisters lollipops "Halloween" and sticks
for 45 prints - 5 designs - Weight: ± 15 g



074321

14 Moulds "Grimoire Halloween"
for 4 pieces 10 x 13 cm - Th. 4 cm
Weight: ± 160 g



NEW 088236

12 Moulds "Chauve-souris"
for 6 pieces 10 x 14,2 cm - Th. 4,65 cm
Weight: ± 65 g



NEW 088237

10 Moulds "Fiole" for
5 pieces 14 x 3,4 cm
Th. 6,8 cm - Weight: ± 65 g

NEW 088186

15 Transfer sheets "Elixir magique"
3 designs 3,4 x 2,8 cm - N/A: USA,
China, Japan, UAE, Saudi Arabia, Qatar,
Kuwait, Bahrain, Oman, South Korea

ENTREMETS MOULDS



🌿 074234
30 Individual entremets moulds
"Citrouille" for 120 pieces
8,5 x 8,9 cm - H. 3,3 cm
Moulds with support jamba



🌿 070529
30 Individual entremets moulds
"Citrouille" for 120 pieces
ø 7,5 cm - H. 1,8 cm
Moulds with support jamba



🌿 070511
30 Individual entremets moulds
"Souche" for 120 pieces
ø 7 cm - H. 3,5 cm
Moulds with support jamba

CAMILLE

Lesucy



🌿 070517
30 Entremets moulds "Souche"
for 30 pieces ø 18 cm - H. 4 cm
Moulds with support jamba

ANGELO

Musa



🌿 065150
5 Structure sheets pre-folded
"Bois" for cube 10 cm

🌿 005018
100 Rhodoïde sheets
neutral 10 x 10 cm

🌿 009952
1 Mould "Cube" for 5 pieces
10 x 10 cm - H. 10 cm

🌿 009910
1 Inox mould Cube
10 x 10 cm - H. 10 cm



🌿 070530
30 Entremets moulds "Citrouille"
for 30 pieces ø 16 cm - H. 4,4 cm
Moulds with support jamba



074243
30 Entremets moulds "Citrouille"
for 30 pieces 15,8 x 16,5 cm - H. 4,7 cm
Moulds with support jamba

HAPPY THANKSGIVING

**NEW** 088054

110 Rectangles Dark choc "Happy Thanksgiving" 7 x 2 cm • N/A: China, Japan, UAE, Saudi Arabia, Qatar, Kuwait, Bahrain, Oman

**NEW** 088135

150 Turkeys Milk choc "Glouglou" 3 designs 2,6 x 3 cm • N/A: China, Japan, UAE, Saudi Arabia, Qatar, Kuwait, Bahrain, Oman, Hong Kong

**070361**

154 Small maple leaves compound "Automne" 3 designs 3,15 x 3,1 cm • N/A: China, UAE, Saudi Arabia, Qatar, Kuwait, Bahrain, Oman

**NEW** 088055

96 Squares White choc "Happy Thanksgiving" 4 cm • N/A: China, Japan, UAE, Saudi Arabia, Qatar, Kuwait, Bahrain, Oman

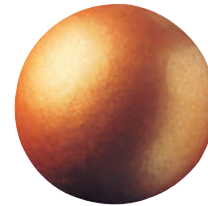
**000222**

63 Balls White choc coated gold ø 2,6 cm - N/A: USA, China, Japan, Qatar, South Korea

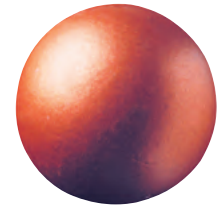
**000218**

63 Balls White choc coated copper ø 2,6 cm - N/A: USA, China, Japan, Qatar, South Korea

**NEW** 070432

300 Leaves White Choc "Automne" 4 designs - N/A: USA, China, Singapore

**NEW** 088056

88 Rounds White choc "Thanks" ø 3 cm • N/A: China, Japan, UAE, Saudi Arabia, Qatar, Kuwait, Bahrain, Oman

**010379**

Crunchies milk - 500 g - N/A: Canada, China, Japan



ADVENT CALENDARS

This year, PCB Création is offering four Advent Calendars designs to keep food lovers waiting! It consists of a two-panel cardboard case with 24 pre-cut windows and two blisters of 12 shapes each (on the theme of Christmas animals). These blisters to be filled, will showcase the quality of your homemade chocolate.



- 087008**
 10 Advent Calendars "La Fabrique à jouets" to fill - in french
 10 packing boxes book shaped with precut windows, 20 Molds to fill, 12 imprints each
 Size: closed 19 x 21 x 3,5 cm, width open 41,5 cm
 Chocolate weights: ± 6 g



- 070399**
 10 Advent Calendars "Casse Noisette" to fill - in french
 10 packing boxes book shaped with precut windows, 20 Molds to fill, 12 imprints each
 Size: closed 19 x 21 x 3,5 cm, width open 41,5 cm
 Chocolate weights: ± 6 g



- 074334**
 10 Advent Calendars "Santa Express" to fill - in french
 10 packing boxes book shaped with precut windows, 20 Molds to fill, 12 imprints each
 Size: closed 19 x 21 x 3,5 cm, width open 41,5 cm
 Chocolate weights: ± 6 g



- NEW 088057**
 10 Advent Calendars "Le village pain d'épices" to fill
 10 packing boxes book shaped with precut windows, 20 Molds to fill, 12 imprints each
 Size: closed 19 x 21 x 3,5 cm, width open 41,5 cm
 Chocolate weights: ± 6 g





Discover our new Advent calendar concept!

A cardboard case with 24 pre-cut windows which create a book,
It comes with two blister packs which contain 24 boxes to be filled with your most delicious creations.
Size of the boxes to fill: 3,2 x 4,2 cm - H. 2,5 cm

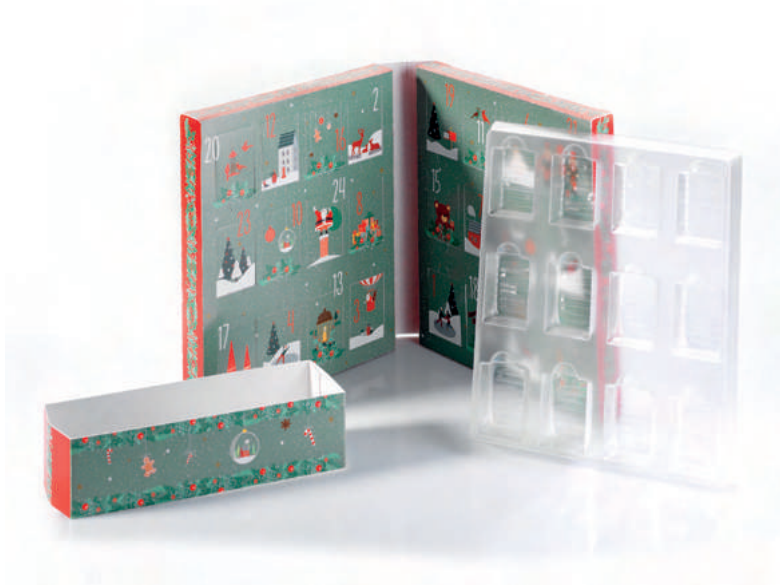

074330

10 Advent Calendars "Village de Noël" to be filled

10 packing boxes book shaped with precut windows, 20 Molds to fill, 12 imprints each - Dimensions: closed 19 x 21 x 5,5 cm, width open 43,5 cm



NEW 088058

10 Advent Calendars "Un Noël à Versailles" to be filled

10 packing boxes book shaped with precut windows, 20 Molds to fill, 12 imprints each - Dimensions: closed 19 x 21 x 5,5 cm, width open 43,5 cm



Please note the ends of yule log are not shown in real size.

DECORATIONS

EMBOSSED PIECES



060362
105 Snowflakes Dark choc, Choc BC and White choc embossed - 3 designs 3,8 x 4,3 cm



074209
70 Rounds Dark choc embossed "Horloge" ø 4 cm



065031
72 Snowflakes White choc embossed "Blanc" 4 x 4,5 cm



NEW 088216
144 Stars Dark choc embossed "Finesse" 4 designs 3,5 x 3,6 cm



NEW 088148
96 Snowflakes Dark choc embossed "Givré" - 3 designs 3,5 x 4 cm



065048
72 Ends of yule log Dark choc embossed "Paysage enneigé" 8,5 x 7,5 cm



NEW 088023
72 Ends of yule log Dark choc embossed "Nuit de Noël" 8,5 x 7,5 cm

Free of colouring Worldwide • Azo



060357
72 Stars Dark choc embossed 4 designs



CHRISTMAS & NEW YEAR

DECORATIONS



060488

63 Balls White choc crystallised bronze ø 3 cm - N/A: USA, China, Japan, Qatar, South Korea



065288

63 Balls White choc crystallised gold ø 3 cm - N/A: USA, China, Japan, Qatar, South Korea



065291

63 Balls White choc crystallised red ø 3 cm - N/A: USA, China, Japan, South Korea



000222

63 Balls White choc coated bronze ø 2,6 cm - N/A: USA, China, Japan, Qatar, South Korea



065285

63 Balls White choc coated red ø 2,6 cm - N/A: USA, China, Japan, South Korea

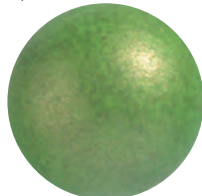

070478

63 Balls White choc coated dark green ø 2,6 cm - N/A: USA, China, Japan, Qatar, South Korea



050243

63 Balls White choc coated orange ø 2,6 cm - N/A: USA, China, Japan



050246

63 Balls White choc coated light green ø 2,6 cm - N/A: USA, China, Japan

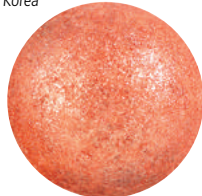

060487

63 Balls White choc crystallised gold ø 2,6 cm N/A: USA, China, Japan, Qatar, South Korea



065287

63 Balls White choc crystallised red ø 2,6 cm N/A: USA, China, Japan, Qatar, South Korea



065290

63 Balls White choc crystallised bronze ø 2,6 cm N/A: USA, China, Japan, South Korea

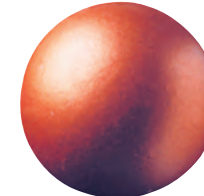

000218

63 Balls White choc coated copper ø 2,6 cm - N/A: USA, China, Japan, Qatar, South Korea



000220

63 Balls White choc coated gold ø 2,6 cm - N/A: USA, China, Japan, UAE, Saudi Arabia, Qatar, Kuwait, Oman, Bahrain, South Korea,



065286

63 Balls White Choc crystallised gold ø 2 cm N/A: USA, China, Japan, Qatar, South Korea



065289

63 Balls White Choc crystallised red ø 2 cm - N/A: USA, China, Japan, South Korea



060489

63 Balls White Choc crystallised bronze ø 2 cm - N/A: USA, China, Japan, Qatar, South Korea

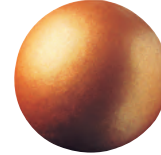

000221

63 Balls White Choc coated bronze ø 2 cm - N/A: USA, China, Japan, Qatar, South Korea



050247

63 Balls White Choc coated orange ø 2 cm - N/A: USA, China, Japan



000219

63 Balls White choc coated gold ø 2 cm N/A: USA, China, Japan, UAE, Saudi Arabia, Qatar, Kuwait, Bahrain, Oman, South Korea



070477

63 Balls White choc coated dark green ø 2 cm - N/A: USA, China, Japan, Qatar, South Korea



065284

63 Balls White Choc coated red ø 2 cm N/A: USA, China, Japan, South Korea

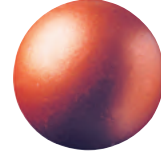

000217

63 Balls White Choc coated copper ø 2 cm - N/A: USA, China, Japan, Qatar, South Korea



050250

63 Balls White Choc coated light green ø 2 cm - N/A: USA, China, Japan,

Free of colouring Worldwide • Azo



DECORATIONS



070495
88 Balls White choc "Rose de Noël" 2 designs ø 3 cm
N/A: China, Japan



060480
88 Balls Dark choc "Noël bronze" 3 designs ø 3 cm
N/A: USA, China, Japan, UAE, Saudi Arabia, Kuwait, Oman, Bahrain, Qatar, South Korea



087021
88 Balls Dark choc "Baroque" 2 designs ø 3 cm
N/A: USA, China, Japan, UAE, Saudi Arabia, Qatar, Kuwait, Bahrain, Oman, South Korea



070497
88 Balls White choc "Flocon" 3 designs ø 3 cm - N/A: USA, China, Japan, UAE, Saudi Arabia, Qatar, Kuwait, Bahrain, Oman, South Korea



065097
88 Balls White choc "Noël nordique" 3 designs ø 3 cm
N/A: China, Japan



074232
88 Balls White choc "Candy cane" ø 3 cm - N/A: China, Japan, Singapore
087020
88 Balls Dark choc "Ornement" ø 3 cm
N/A: USA, China, Japan, UAE, Saudi Arabia, Kuwait, Oman, Bahrain, Qatar, South Korea



070499
88 Balls Dark choc "Vitrail" 3 designs ø 3 cm
N/A: USA, China, Japan, UAE, Saudi Arabia, Qatar, Kuwait, Bahrain, Oman, South Korea



NEW 088031
88 Balls White choc "Kelsch" 3 designs ø 3 cm - N/A: China, Japan, Hong Kong



NEW 088030
88 Balls White choc "Hiver pourpre" 3 designs ø 3 cm - N/A: USA, China, Japan, UAE, Saudi Arabia, Qatar, Kuwait, Bahrain, Oman, South Korea



DECORATIONS



NEW 088029

72 Christmas balls White choc "Graphique" 3 designs 3 x 3,7 cm - N/A: USA, China, Japan, Qatar, South Korea

002748

72 Christmas balls White choc "Rouge" 3 designs 3 x 3,7 cm • N/A: USA, Canada, China, Japan, UAE, Saudi Arabia, Qatar, Kuwait, Bahrain, Oman, South Korea



074203

63 Grelots White choc coated bronze ø 2,6 cm
N/A: USA, China, Japan, Qatar, South Korea



060484

72 Christmas balls Dark choc "Cuirve étincelant" 3 designs
3 x 3,7 cm - N/A: USA, China, Japan, UAE, Saudi Arabia, Qatar, Kuwait,
Bahrain, Oman, South Korea



036124

63 Balls Dark choc "Bilbo" 3 designs ø 2,6 cm
N/A: USA, China, Japan, Qatar, South Korea



NEW 060493

54 Penguins White choc 2,3 x 3,6 cm
N/A: USA, China, South Korea, Singapore



NEW 060494

54 Santas White choc 2,3 x 3,6 cm - N/A: China,
Singapore



074283

126 Gifts Dark & White choc 2 designs 3,2 x 3,2 cm
N/A: USA, China, Japan, Qatar, South Korea



070281

88 Gifts Dark choc 2 designs 2,2 x 2,2 cm
N/A: USA, China, Japan, UAE, Saudi Arabia, Qatar, Kuwait,
Bahrain, Oman, South Korea



NEW 088130

63 Balls Dark choc
"Truffe" ø 2 cm



NEW 088131

63 Balls Dark choc
"Truffe" ø 2,6 cm



NEW 088132

63 Balls White choc
"Neige" ø 2 cm



NEW 088133

63 Balls White choc
"Neige" ø 2,6 cm



DECORATIONS



003584
48 Stars Dark choc 3D 4,6 x 4,6 cm



074282
70 Chalets Dark choc 3D 2,5 x 2,5 cm



074279
72 Christmas trees Dark choc 3D 2,5 x 3 cm



074280
72 Christmas trees Choc BC 3D 2,5 x 3 cm



074281
72 Christmas trees White choc 3D 2,5 x 3 cm



NEW 074284
88 Chestnuts Milk choc 3D 3 x 2,6 cm - N/A: USA, China, Japan, South Korea, Singapore



NEW 087103
63 Hazelnuts Milk choc 3D ø 2,6 cm - N/A: USA, China, Japan, UAE, Saudi Arabia, Qatar, Kuwait, Bahrain, Oman, South Korea, Singapore



NEW 088226
176 Hazelnuts Milk choc "Striées" 3D 2,9 x 3 cm



NEW 088223
70 Bears White choc "Teddy" 3D 2,6 x 3,7 cm



NEW 088224
70 Bears Choc BC "Teddy" 3D 2,6 x 3,7 cm



NEW 088225
70 Bears Milk choc "Teddy" 3D 2,6 x 3,7 cm



070242
72 Acorns Choc BC 3D 3 x 3,8 cm



NEW 088227
140 Acorns Milk choc 3D 2,85 x 3,5 cm



060491
88 Mushrooms White choc "Rouge" 3 designs 3D ø 3 cm
N/A: China, Singapore



060492
88 Mushrooms Dark choc "Bronze" 3 designs 3D ø 3 cm
N/A: USA, China, Japan, Qatar, South Korea



060250
88 Mushrooms White choc "Caramel" 3 designs 3D ø 3 cm



DECORATIONS



070071

80 Small mushrooms Choc BC "Lutin"
1,5 x 3 cm • N/A: UAE, Saudi Arabia,
Qatar, Kuwait, Bahrain, Oman



070124

91 Mini-Mushrooms White choc 3 designs • N/A: UAE, Saudi
Arabia, Qatar, Kuwait, Bahrain, Oman



NEW 065182

108 Mushroom tops
Compound ø 2,5 cm
N/A: China, Singapore



NEW 060502

190 Mini-sticks White Choc "Candy"
3 designs 5 x 0,6 cm - N/A: China, Japan, UAE, Saudi
Arabia, Qatar, Kuwait, Bahrain, Oman



070067

176 Mushrooms Choc BC "Todds" 2 designs • N/A: UAE, Saudi
Arabia, Qatar, Kuwait, Bahrain, Oman



060279

150 Gingerbread White choc 3 designs



NEW 088059

168 Small penguins White choc "Frileux" 3 designs - N/A: China, Japan, UAE,
Saudi Arabia, Qatar, Kuwait, Bahrain, Oman, Hong Kong



070419

120 Vintage toys Choc BC 5 designs - N/A: China, Singapore



070120

90 Gingerbread houses Milk choc "Pain d'épice" 2 designs • N/A: UAE, Saudi
Arabia, Qatar, Kuwait, Bahrain, Oman



070063

84 Reindeers Choc BC "Kawai" 4,1 x 5 cm
• N/A: UAE, Saudi Arabia, Qatar, Kuwait, Bahrain,
Oman



060256

128 Biscuits Choc BC "En famille" 4 designs 2,6 x 4,3 cm



NEW 088098

140 Santa Claus White choc "En action" 5 designs- N/A: USA, China, Japan, UAE, Saudi Arabia, Qatar,
Kuwait, Bahrain, Oman, South Korea, Hong Kong

DIY



070283
78 Polar bears White choc
2,4 x 3,8 cm



NEW 087107
2 Blisters "Pomme de pin" so 108 prints to
create 12 pine cones ± 4 x 5 cm

DECORATIONS

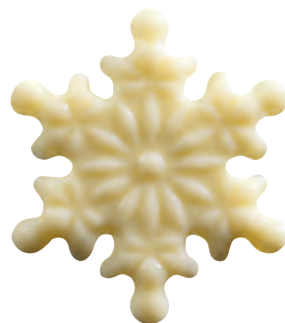

070349
120 Small snowflakes White choc
3,5 x 4 cm



000256
154 Christmas trees Dark choc 4 designs 2,7 x 3,5 cm
N/A: UAE, Saudi Arabia, Qatar, Kuwait, Bahrain, Oman

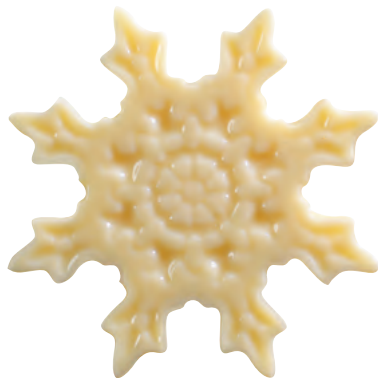

060276
70 Snowflakes embossed White choc ø 5 cm



004904
56 Christmas trees Dark choc "Bulles" 5 x 5,5 cm

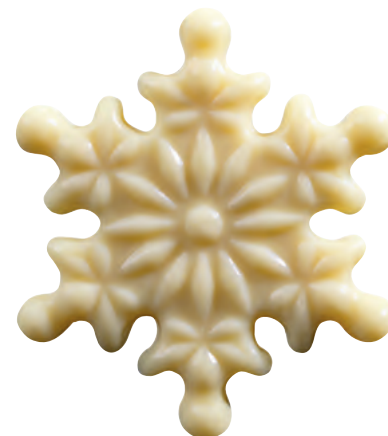

070351
60 Large snowflakes White choc 5 x 5,7 cm



070352
60 Large snowflakes Dark choc 5 x 5,7 cm

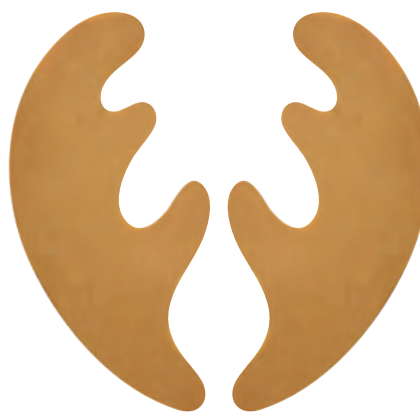

036115
60 Antlers Choc BC 2 designs 2,5 x 5,2 cm



070350
120 Small snowflakes Dark choc
3,5 x 4 cm

070064
36 Skis "Bois" Choc BC
1,5 x 13,7 cm

Free of colouring • Worldwide • Azo

DECORATIONS



DIY



087044
208 Santa belt buckle
compound 2,5 cm
N/A: China, Japan, Hong Kong



070398
162 Snowflakes Dark choc, Choc BC and White choc 3,7 x 3,4 cm



060518
143 Acorns Compound "Scintillants"
2 designs 1,8 x 2,5 cm - N/A: USA, China,
Japan, UAE, Saudi Arabia, Qatar, Kuwait,
Bahrain, Oman, South Korea

010714
1 Stencil for reindeer antlers 12 prints 3 designs 5 x 6 cm



070345
143 Acorns Choc BC 1,8 x 2,5 cm



036102
144 Christmas trees Dark choc "Mon beau sapin" 4 designs



004873
150 Snowflakes White choc 4,2 x 4,8 cm



070121
56 Reindeers Dark choc "Rudolph"
5,2 x 6,1 cm • N/A: UAE, Saudi Arabia, Qatar,
Kuwait, Bahrain, Oman



065297
60 Small pine cones Milk choc
3 x 3,5 cm



074247
453 Christmas trees extra thin Dark choc, Choc BC and White choc - 9 designs - 2,5 x 3 cm - 3 x 3 cm - 4 x 4 cm

Free of colouring • Worldwide • Azo



DECORATIONS



070130
90 Santa Claus heads White choc 2 designs • N/A: UAE, Saudi Arabia, Qatar, Kuwait, Bahrain, Oman



060504
84 Santa Claus heads White choc 3,8 x 5 cm - N/A: China, Japan, Singapore



070433
110 Signs White choc "Père Noël" 3 designs 3 x 4,4 cm N/A: China, Singapore



074272
100 Stamps White choc "Collection Noël" 3 designs 3,3 x 4,5 cm - N/A: USA, China, Japan, UAE, Saudi Arabia, Qatar, Kuwait, Bahrain, Oman, South Korea



NEW 088061
90 Santa heads White choc 3,6 x 4,5 cm - N/A: UAE, Saudi Arabia, Qatar, Kuwait, Bahrain, Oman



087040
90 Decorations White choc "Père Noël et Bonhomme de neige" 2 designs N/A: China, Japan, Hong Kong



070136
70 Santa Claus heads White choc 4,6 x 5 cm • N/A: UAE, Saudi Arabia, Qatar, Kuwait, Bahrain, Oman



065134
140 Santa Claus heads White choc 3 x 3 cm N/A: China, Japan, UAE, Saudi Arabia, Qatar, Kuwait, Bahrain, Oman, Singapore



NEW 088062
80 Santas White Choc "Sur son traîneau" 4,5 x 4,1 cm - N/A: UAE, Saudi Arabia, Qatar, Kuwait, Bahrain, Oman



NEW 088063
90 Snowmen White Choc "Sur son traîneau" 3,85 x 4,5 cm - N/A: UAE, Saudi Arabia, Qatar, Kuwait, Bahrain, Oman



065205
140 Drops White choc "Tête de Père Noël" 2 designs - N/A: China, Japan, Singapore

DECORATIONS



070492
176 Rounds White choc "Candy" 4 designs ø 2 cm
N/A: USA, China, Singapore

060259
176 Rounds White choc "Sucre d'orge" 3 designs ø 3 cm
N/A: USA, China

060281
35 Snowflakes White Choc "Vert et Rouge"
ø 5 cm - N/A: USA, China



NEW 088099
120 Gingerbreads White choc "Les gourmands" 3 designs - N/A: China, Japan, South Korea

070070
80 Gingerbreads White choc "Père et Mère Noël" 5 designs • N/A: China, UAE, Saudi Arabia, Qatar, Kuwait, Bahrain, Oman, Taiwan

060270
80 Gingerbreads White choc "Père et Mère Noël" 5 designs - N/A: USA, China



065186
72 Christmas trees White choc
to stick in 5,7 x 3,9 cm
N/A: USA, China, Japan



NEW 088060
156 Christmas stocks Compound "Noël" 5 designs - N/A: China, Japan, UAE, Saudi Arabia, Qatar, Kuwait, Bahrain, Oman, Hong Kong

070114
160 Gifts White choc "Noël" 12 designs •
N/A: Canada, China, UAE, Saudi Arabia, Qatar, Kuwait, Bahrain, Oman, South Korea



060263
50 Christmas trees Barley grass
3,4 x 5 cm - N/A: USA, China



065082
300 Christmas balls White choc "Acidulé" 5 designs 1,8 x 2,2 cm
N/A: USA, China



065175
300 Snowmen White choc 4 designs 1,4 x 2,6 cm - N/A: USA, China

Free of colouring • Worldwide • Azo

DECORATIONS



070131
70 Rounds Choc BC "Rodolphe" ø 5 cm • N/A: UAE, Saudi Arabia, Qatar, Kuwait, Bahrain, Oman



065179
60 Gingerbread houses White Choc "Gretel" 3 designs
N/A: China, Japan



060254
108 Reindeer heads White Choc
3,6 x 4 cm



065183
60 Bears Choc BC "Emmitouflés"
3 x 3,8 cm - N/A: China, Singapore



060271
90 Gingerbread houses White choc "Pain d'épices" 2 designs



NEW 087138
182 Gingerbreads White Choc "Pain d'épices"
3 designs - N/A: USA, China, Japan, South Korea



074285
120 Nutcrackers Dark choc
2,5 x 5 cm - N/A: USA, China, Japan, UAE, Saudi Arabia, Qatar, Kuwait, Bahrain, Oman, South Korea



087056
56 Sugar candy White choc
3,4 x 9,5 cm - N/A: China, Japan



060272
150 Crystallised Raspberry snowflakes 4,2 x 4,8 cm



060255
56 Reindeers Choc BC 5,2 x 6,1 cm



070195
110 Snowmen White choc
2,6 x 5 cm •
N/A: China, UAE, Saudi Arabia, Qatar, Kuwait, Bahrain, Oman, Taiwan



087055
150 Small Sugar candy White choc 2 x 4 cm - N/A: China, Japan

DECORATIONS

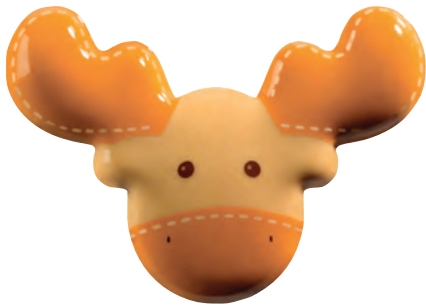

060520

100 Reindeers heads Choc BC "Poro" 3,2 x 4,5 cm
N/A: USA, China, Japan, UAE, Saudi Arabia, Qatar, Kuwait,
Bahrain, Oman, South Korea, Singapore



074204

96 Stars compound "Dorées" 4 x 4,5 cm
N/A: USA, China, Japan, Qatar, South Korea



NEW 087139

66 Bears Dark Choc "Sur la banquise" 2 designs



045717

90 Teddy bears White choc "Blanc"
4,1 x 5,5 cm



087043 ●●●●

2 Blisters "Boucle de ceinture" so 96 prints
4 x 4 cm - N/A: China, Japan, Hong Kong



NEW 087140

66 Bears Choc BC "Sur la banquise" 2 designs



NEW 087141

66 Bears White Choc "Sur la banquise" 2 designs



065063

56 Reindeers Milk choc "Rudolphe" 5,2 x 6,1 cm



074296

130 Bottles Dark
choc 2 x 5,2 cm
N/A: UAE, Saudi
Arabia, Qatar, Kuwait,
Bahrain, Oman



074287

182 Moons and stars compound 4 designs
N/A: USA, China, Japan, UAE, Saudi Arabia, Qatar, Kuwait,
Bahrain, Oman, South Korea



004843

60 Barriers Dark choc "3 branches" 5,6 x 4,6 cm





DECORATIONS



065111

96 Stars White choc "Graphique" 2 designs 4,3 x 4,5 cm - N/A: China, Japan, UAE, Saudi Arabia, Qatar, Kuwait, Bahrain, Oman



036100

120 Stars Choc BC "Firmament" 4 designs



060260

252 Stars Mango, Strawberry and Raspberry
3 designs 3 x 2,8 cm - N/A: Taiwan

045687

120 Stars Raspberry 4 designs

NEW 088105

216 Stars White choc "Acidulé"
4 designs 3 x 3 cm - N/A: USA, China, Japan



065199

186 Stars White choc "Colorées" 3 designs - N/A: USA, China, Japan

045647

120 Stars Crystallized White choc 4 designs

DECORATIONS



036099
 120 Stars Dark choc "Firmament" 4 designs



004906
 48 Stars Dark choc "Bulles" 6,3 x 6,4 cm



008670
 Stars Dark choc shiny bronze
 1,8 x 1,4 cm - 200 g
 N/A: USA, China, Japan, UAE, Saudi Arabia, Qatar, Kuwait, Bahrain, Oman, South Korea

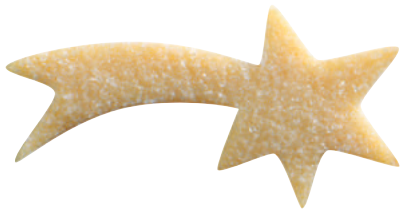

074292
 150 Shooting stars Crystallized White choc 6,6 x 3,5 cm



003688
 120 Stars Dark choc "Arabesques" 2 designs 3,45 x 3,6 cm



NEW 088228
 80 Stars Dark choc "Facettes" 4,5 cm



003541
 186 Stars Dark choc, Milk choc and White choc 3 designs

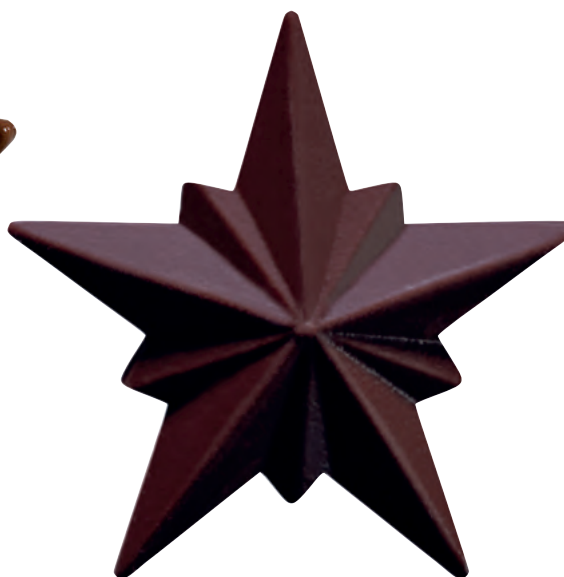

NEW 088229
 60 Stars Dark choc "Facettes" 7,5 cm



060516
 120 Stars Dark choc "Pluie d'étoiles" 4 designs
 N/A: USA, China, Japan, UAE, Saudi Arabia, Qatar, Kuwait, Bahrain, Oman, South Korea

Free of colouring • Worldwide • Azo



DIY

087064
10 Blisters "Étoile filante"
so 50 prints 20 x 7,8 cm

(088098 - Santa Claus "En action"
+ 088040 - Squares "Season's
greetings" + 010294 - Structure sheets
"Rondin" + 074239 Yule log moulds
"6 parts")



DECORATIONS



074352

110 Rectangles CN "Merry Christmas" 7 x 2 cm - N/A: USA, China, Japan, UAE, Saudi Arabia, Qatar, Kuwait, Bahrain, Oman, South Korea



074298

110 Rectangles Dark choc "Happy Holidays" 7 x 2 cm - N/A: UAE, Saudi Arabia, Qatar, Kuwait, Bahrain, Oman



NEW 088042

110 Rectangles White choc "Merry Christmas" 7 x 2 cm - N/A: China, Japan, Hong Kong



074301

162 Rectangles Dark choc "Traineau" 3,8 x 2,3 cm • N/A: UAE, Saudi Arabia, Qatar, Kuwait, Bahrain, Oman



NEW 088065

112 Rectangles Dark choc "Season's greetings" 5 x 3 cm • N/A: UAE, Saudi Arabia, Qatar, Kuwait, Bahrain, Oman



NEW 088044

140 Squares Choc BC "Christmas decoration" 3,5 cm - N/A: China, Japan, Hong Kong



Customize all our products in your language!



074302

63 Wax seals Compound "Merry Christmas" ø 3,5 cm • N/A: UAE, Saudi Arabia, Qatar, Kuwait, Bahrain, Oman



087042

63 Wax seals Compound "Merry Christmas" ø 3,5 cm - N/A: China, Japan



060467

96 Rounds Dark choc "Joyeux Noël" ø 4 cm N/A: USA, China, Japan, UAE, Saudi Arabia, Qatar, Kuwait, Bahrain, Oman, South Korea



074300

96 Rounds Dark choc "Merry Christmas" ø 4 cm - N/A: UAE, Saudi Arabia, Qatar, Kuwait, Bahrain, Oman



074299

96 Squares Dark choc "Merry Christmas" 4 cm 2 designs - N/A: UAE, Saudi Arabia, Qatar, Kuwait, Bahrain, Oman



NEW 088045

96 Squares Compound "Christmas" 4 cm - N/A: China, Japan, Hong Kong



NEW 088040

140 Squares White choc "Season's greetings" 3,5 cm - N/A: China, Japan, Hong Kong



074255
4 Blisters "Horloge Tic Tac"
so 12 prints ø 15,5 cm

Happy New Year

070471

70 Rectangles White choc "Happy New Year" 7 x 1,5 cm



070472

55 Rectangles Dark choc "Happy New Year Stars" 7 x 2 cm - N/A: UAE, Saudi Arabia, Qatar, Kuwait, Bahrain, Oman



NEW 088064

110 Rectangles Dark choc "Happy New Year" 7 x 2 cm • N/A: China, UAE, Saudi Arabia, Qatar, Kuwait, Bahrain, Oman



070463

55 Rectangles Dark choc "Happy New Year" 7 x 2 cm - N/A: UAE, Saudi Arabia, Qatar, Kuwait, Bahrain, Oman



NEW 088046

88 Rounds Dark choc "Happy new year" ø 3 cm
N/A: USA, China, Japan, UAE, Saudi Arabia, Qatar, Kuwait, Bahrain, Oman, South Korea



070464

88 Rounds Dark choc "Horloge"
ø 3 cm - N/A: UAE, Saudi Arabia, Qatar, Kuwait, Bahrain, Oman

Bonne année

065116

120 Rectangles White choc "Bonne Année"
5 x 1,7 cm - N/A: USA, China, Japan, UAE, Saudi Arabia, Qatar, Kuwait, Bahrain, Oman, South Korea

DECORATIONS



NEW 088101

50 Rectangles White choc "Shiny new year" 4 x 6 cm - N/A: USA, China, Japan, UAE, Saudi Arabia, Qatar, Kuwait, Bahrain, Oman, South Korea, Hong Kong



074296

130 Bottles Dark choc
2 x 5,2 cm - N/A: UAE, Saudi Arabia, Qatar, Kuwait, Bahrain, Oman



003300

88 Rounds Dark choc "Horloge"
ø 3 cm - N/A: USA, China, Japan, UAE, Saudi Arabia, Qatar, Kuwait, Bahrain, Oman, South Korea



087037 ●●●●

2 Blisters "Horloge et aiguilles" so 36 prints (12 clocks) 3 designs ø 11,2 cm - N/A: China, Japan, Hong Kong

Free of colouring • Worldwide • Azo • Usable chocolates

NEW YEAR DECORATIONS

(087138 - Gingerbreads "Pain d'épices"
+ 003870 - Ends of yule log + 088194
Yule log moulds "Pyramide")



Please note the ends of yule log are not shown in real size.

DECORATIONS



070127

60 Ends of yule log White choc "Vortex" ø 6 cm • N/A: UAE, Saudi Arabia, Qatar, Kuwait, Bahrain, Oman



003870

18 Ends of yule log Dark choc 8,7 x 9,5 cm

ENDS OF YULE LOG

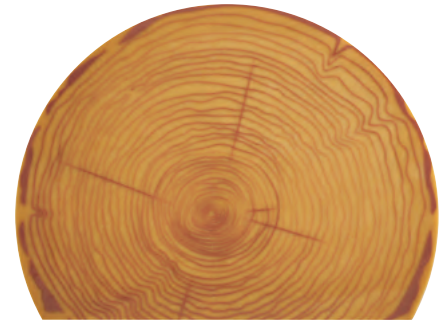

045776

40 Ends of yule log Choc BC "Strates" 8 x 6 cm



036106

75 Ends of yule log Dark choc "Coupe" 8,2 x 7 cm



065211

75 Ends of yule log Dark Choc "Joyeuses Fêtes" 8,2 x 6,8 cm
N/A: USA, China, Japan, UAE, Saudi Arabia, Qatar, Kuwait, Bahrain, Oman, South Korea



070458

75 Ends of yule log Choc BC "Casse Noisette" 8,5 x 7,5 cm
N/A: USA, China, Japan, UAE, Saudi Arabia, Qatar, Kuwait, Bahrain, Oman, South Korea, Singapore



NEW 060402

40 Ends of yule log White Choc "Rennes" 2 designs 8,5 x 8 cm - N/A: USA, China, Japan, UAE, Saudi Arabia, Qatar, Kuwait, Bahrain, Oman, South Korea, Singapore



NEW 088049

75 Ends of yule log Dark choc "Envol" 8,5 x 7,5 cm - N/A: USA, China, Japan, UAE, Saudi Arabia, Qatar, Kuwait, Bahrain, Oman, South Korea

Free of colouring Worldwide • Azo

(070386 - Ends of yule log "Ondulation"
+ 065066 - Structure sheets "Envol"
for yule log + 070587 - Yule log moulds
"Standard")



DECORATIONS

Please note the ends of yule log are not shown in real size.



036063
75 Ends of yule log Extra thin Dark choc 8,5 x 7,5 cm



036064
75 Ends of yule log Extra thin Choc BC 8,5 x 7,5 cm



036065
75 Ends of yule log Extra thin White choc 8,5 x 7,5 cm

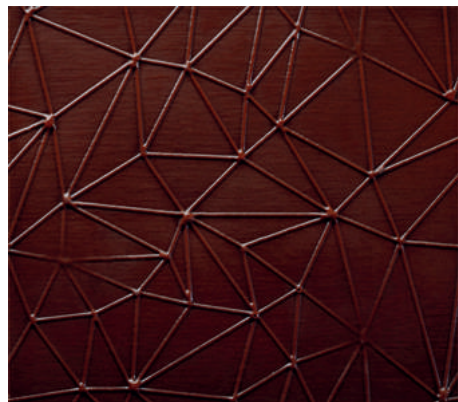

087069
24 Ends of yule log extra thin embossed Dark choc "Polygone" 8,5 x 7,5 cm

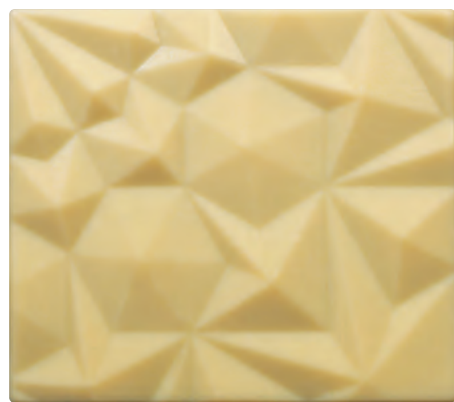

002880
30 Ends of yule log White choc "Origami" 8,5 x 7,5 cm

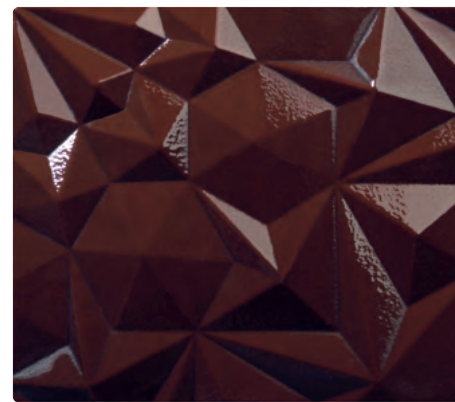

003989
30 Ends of yule log Dark choc "Origami" 8,5 x 7,5 cm



NEW 065049
75 Ends of yule log Dark choc "Spirale" 8,5 x 7,5 cm

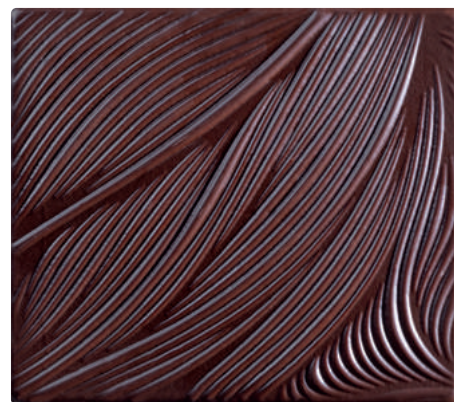

070386
75 Ends of yule log Dark choc "Ondulation" 8,5 x 7,5 cm
Free of colouring Worldwide • Azo



074273
75 Ends of yule log Dark choc "Branchage" 8,5 x 7,5 cm



SMALL ENDS
OF YULE LOG**NEW** 088102

120 Small ends of yule log White choc
"Couronne hivernale" 4 cm - N/A: China,
Japan, Hong Kong

**NEW** 088103

120 Small ends of yule log Dark choc
"Vent d'hiver" 4 cm - N/A: USA, China,
Japan, UAE, Saudi Arabia, Qatar, Kuwait,
Bahrain, Oman, South Korea

**NEW** 088106

140 Small ends of yule log White choc
"Nuit de Noël" 3,9 x 3,95 cm - N/A: USA,
China, Japan, UAE, Saudi Arabia, Qatar, Kuwait,
Bahrain, Oman, South Korea

**NEW** 088107

140 Small ends of yule log Dark choc
"Nuit étoilée" 3,9 x 3,95 cm - N/A: USA,
China, Japan, UAE, Saudi Arabia, Qatar, Kuwait,
Bahrain, Oman, South Korea

**NEW** 088108

140 Small ends of yule log White choc
"Flocon" 3,9 x 3,95 cm - N/A: USA, China,
Japan, UAE, Saudi Arabia, Qatar, Kuwait,
Bahrain, Oman, South Korea

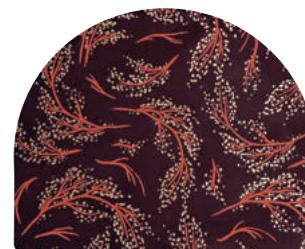
**NEW** 088109

140 Small ends of yule log Dark choc
"Branchage" 3,9 x 3,95 cm - N/A: USA,
China, Japan, UAE, Saudi Arabia, Qatar, Kuwait,
Bahrain, Oman, South Korea

**NEW** 088110

108 Small ends of yule log Dark choc
"Boule de Noël" 4 x 4 cm - N/A: USA,
China, Japan, UAE, Saudi Arabia, Qatar, Kuwait,
Bahrain, Oman, South Korea

**NEW** 088111

108 Small ends of yule log Dark choc
"Volutes" 4 x 4 cm - N/A: USA, China, Japan,
UAE, Saudi Arabia, Qatar, Kuwait, Bahrain,
Oman, South Korea

**NEW** 088112

108 Small ends of yule log Dark choc
"Arabesques" 4 x 4 cm - N/A: USA, China,
Japan, UAE, Saudi Arabia, Qatar, Kuwait,
Bahrain, Oman, South Korea

**NEW** 088113

108 Small ends of yule log Dark choc
"Joyeuses Fêtes" 4 x 4 cm - N/A: USA,
China, Japan, UAE, Saudi Arabia, Qatar, Kuwait,
Bahrain, Oman, South Korea

Please note the decorations are not shown in real size.



DIY



USE THIS KIT WITH THE STANDARD
YULE LOG MOULD 070587 P. 105



070439 ●●●

6 Blisters "Santa Express" for 12 locomotives
N/A: USA, China, Japan, Qatar, South Korea, Singapore

ECLAIR CHOCOLATE TOPPINGS

Please note the references are not shown in real size.

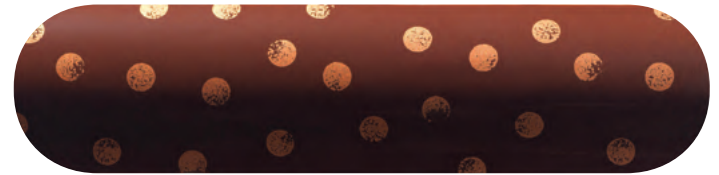

CURVED ECLAIR

040079

24 Curved eclair Dark Choc "Pois bronze" 3 designs 13,2 x 3,2 cm - N/A: USA, China, Japan, UAE, Saudi Arabia, Qatar, Kuwait, Bahrain, Oman, South Korea

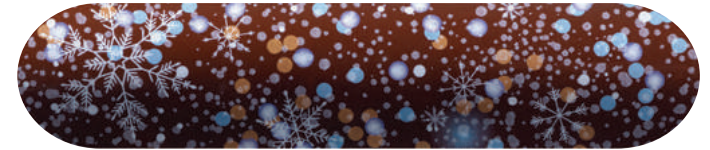

070079

24 Curved eclairs Dark choc "Cristaux" 13,2 x 3,2 cm • N/A: UAE, Saudi Arabia, Qatar, Kuwait, Bahrain, Oman

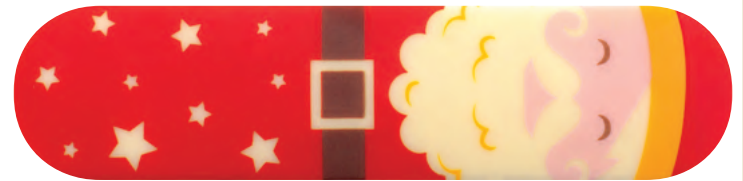

060496

60 Eclairs White choc "Père Noël" 13,2 x 3,2 cm - N/A: USA, China, Singapore

ECLAIR

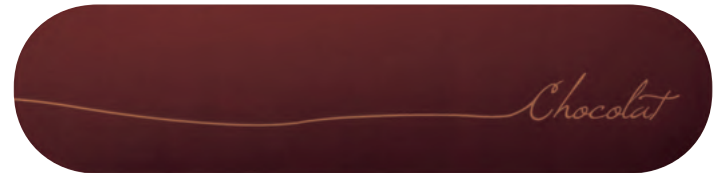

040190

60 Eclairs Dark Choc "Chocolat" 13,2 x 3,2 cm - N/A: China, Singapore

TRANSFER SHEETS



TRANSFER SHEETS

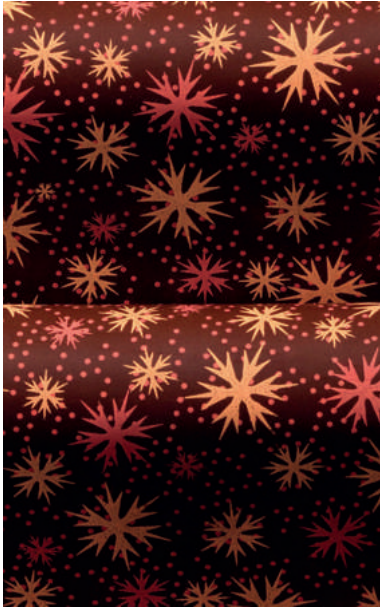

070214 "Solstice" ●●●●●

17 Transfer sheets 40 x 25 cm •

N/A: UAE, Saudi Arabia, Qatar, Kuwait, Bahrain, Oman



087001 "Pluie de flocons" ●●●●●

17 Transfer sheets 40 x 25 cm - N/A: USA, China, Japan, UAE, Saudi Arabia, Qatar, Kuwait, Bahrain, Oman, South Korea



070215 "Antalya" ●●●●●

17 Transfer sheets 40 x 25 cm •

N/A: UAE, Saudi Arabia, Qatar, Kuwait, Bahrain, Oman

There are a thousand and one uses for these transfer sheets. These patterns are available in colours not featured in this catalogue on orders of 125 sheets or more. Let us know what colour you fancy and we'll be delighted to whip up a special edition just for you...



SEE INSTRUCTIONS
ON OUR WEBSITE



NEW 088007 "Pins" ●●●●●

17 Transfer sheets 40 x 25 cm

N/A: USA, China, Japan, UAE, Saudi Arabia, Qatar, Kuwait, Bahrain, Oman, South Korea



NEW 088006 "Baies de houx" ●●●●●

17 Transfer sheets 40 x 25 cm

N/A: USA, China, Japan, UAE, Saudi Arabia, Qatar, Kuwait, Bahrain, Oman, South Korea

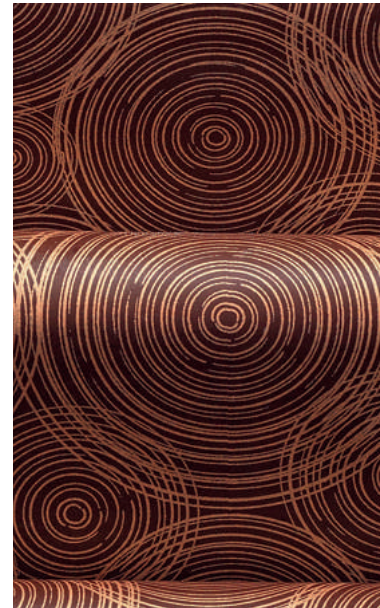

087000 "Rondin" ●●●●●

17 Transfer sheets 40 x 25 cm - N/A: USA, China, Japan, UAE, Saudi Arabia, Qatar, Kuwait, Bahrain, Oman, South Korea



060100 "Froidure" ●●●●●

17 Transfer sheets 40 x 25 cm

N/A: USA, China, Singapore

TRANSFER SHEETS



060342 "Aladine" ●●●●●
17 Transfer sheets 40 x 25 cm
N/A: USA, China, Japan, UAE, Saudi Arabia, Qatar, Kuwait,
Bahrain, Oman, South Korea



060137 "Arabesques scintillantes" ●●●●●
17 Transfer sheets 40 x 25 cm - N/A: USA, China,
Japan, UAE, Saudi Arabia, Qatar, Kuwait, Bahrain,
Oman, South Korea



🌐 **065221** "Joyeuses Fêtes" ●●●●●
17 Transfer sheets 40 x 25 cm

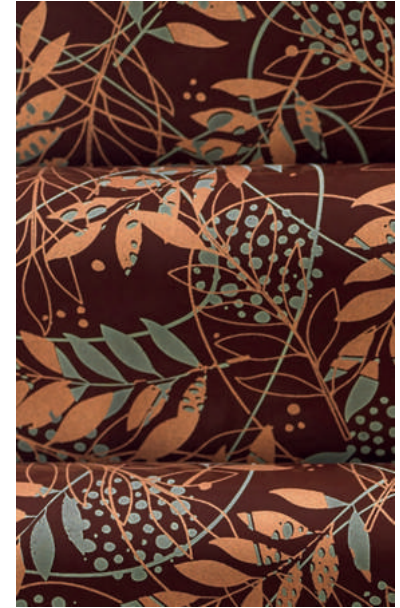

NEW **088001** "Rameaux" ●●●●●
17 Transfer sheets 40 x 25 cm - N/A: USA, China,
Japan, UAE, Saudi Arabia, Qatar, Kuwait, Bahrain,
Oman, South Korea, Hong Kong

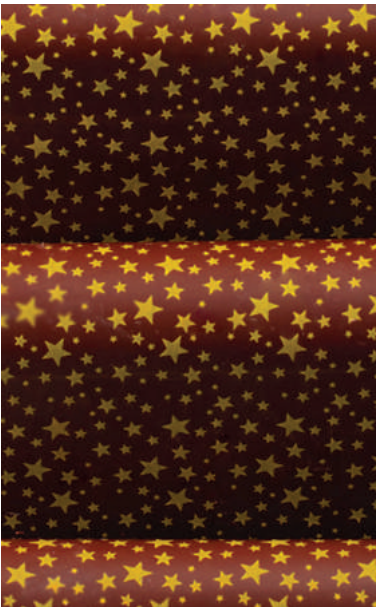

060143 "Constellation" ●●●●●
17 Transfer sheets 40 x 25 cm - N/A: China, Singapore



087050 "Feuilles de Houx" ●●●●●
17 Transfer sheets 40 x 25 cm - N/A: USA, China,
Japan, South Korea, Hong Kong



070462 "Grain de folie" ●●●●●
17 Transfer sheets 40 x 25 cm • N/A: UAE, Saudi Arabia,
Qatar, Kuwait, Bahrain, Oman



065001 "24 Décembre" ●●●●●
17 Transfer sheets 40 x 25 cm
N/A: China, Japan, UAE, Saudi Arabia, Qatar, Kuwait,
Bahrain, Oman, Hong Kong





CHOCOLATE KITS

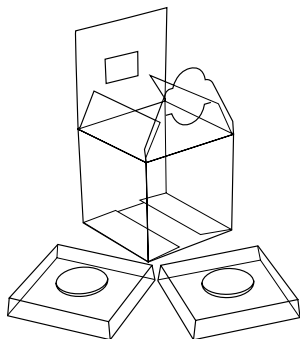

- 004433**
 12 Packing boxes for balls ø 7 cm
 12 plastic boxes + 24 supports
 Dimensions: 8,5 x 8,5 x 8,5 cm
 Dimensions supports: 8,5 x 8,5 x 1,5 cm

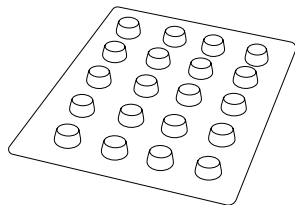

- 009885**
 3 Blisters "Attaches boules" so 60 prints

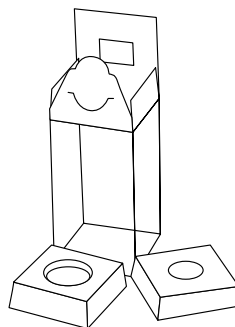

- 004431**
 12 Packing boxes for Matriochkas
 12 plastic boxes + 24 supports



Remember to order
 suitable packaging
 to highlight your
 chocolate products!



- 070017**
 12 Balls White choc "Arabesques" 3 designs ø 7 cm - Weight: ± 50 g • N/A: Canada, UAE, Saudi Arabia, Qatar,
 Kuwait, Bahrain, Oman



- 065243**
 12 Matriochkas White choc "Père Noël"
 H. 10 cm - Weight : ± 45 g - N/A: China,
 Hong Kong, Singapore



SEE INSTRUCTIONS
ON OUR WEBSITE



NEW 088255 ●●●

10 Moulds "Casse noisette"

for 5 pieces 7,95 x 13,5 cm - Weight: ± 100 g
N/A: USA, China, Japan, UAE, Saudi Arabia, Qatar,
Kuwait, Bahrain, Oman, South Korea

KITS



060596 ●●●●

20 Moulds reindeer "Jean-Rudolphe" for 10 pieces
9 x 15 cm - Weight: ± 105 g
N/A: USA, China, Japan, Qatar, South Korea



065274 ●●●●

4 Moulds "Maison pain d'épices" for 4 pieces
11,5 x 11 cm - H. 15,5 cm - Weight: ± 230 g
N/A: China, Singapore, Japan



070437 ●●●●

20 Moulds Santa "Dans ma hotte" for 10 pieces
8,7 x 15 cm - Weight: ± 80 g
N/A: USA, China, Japan, Qatar, South Korea



065242 ●●●●

10 Moulds "Tête de Renne" for 5 pieces 11 x 11 cm
H. 7,6 cm - Weight: ± 90 g
N/A: China, Singapore, Japan



070438 ●●●●

20 Moulds "Sucre d'orge" for 10 pieces
8 x 17 cm - Weight: ± 80 g
N/A: China, Singapore



NEW 087169 ●●●●

16 Moulds "Sven" for 8 pieces
13 x 14,5 cm - Weight: ± 70 g
N/A: USA, China, Japan, UAE, Saudi Arabia, Qatar, Kuwait, Bahrain, Oman, South Korea, Singapore



🌿 045563
20 Moulds "Renne" for 10 pieces
9 x 15 cm - Weight: ± 105 g



060597 ● ● ● ● ●
10 Moulds "Demi-bouteille de champagne"
for 5 pieces 5 x 17,5 cm - Weight: ± 36 g
N/A: USA, China, Japan, UAE, Saudi Arabia, Qatar,
Kuwait, Bahrain, Oman, South Korea

CHRISTOPHE
Michalak



🌿 060212
9 Moulds "Mon Beau Sapin" for 3 pieces
ø 14 cm, ø 11 cm, ø 8 cm, ø 6 cm, ø 4 cm
Weight: ± 100 g



🌿 070429
10 Moulds "Sapin Poché" for 5 pieces
11,6 x 15 cm - Th. 11,8 cm - Weight: ± 100 g



🌿 074317
12 Moulds "Sapin Cône strié"
for 12 pieces - ø 11 cm - H. 12 cm
Weight: ± 55 g



  **NEW** 088238

8 Moulds "Sapin Vrille" for 4 pieces

9,6 x 15 cm - Th. 9,5 cm

Weight: ± 70 g





🌿 087065

12 Moulds "Tablette Couronne de l'Avent" for 12 pieces
18 x 19 cm - H. 1,5 cm - Weight: ± 180 g



🌿 **NEW** 088247

12 Moulds "Tablette P'tit Biscuit" for 12 pieces
11,6 x 14 cm - H. 1,8 cm - Weight: ± 100 g



🌿 074314

12 Moulds "Tablette horloge" for 12 pieces
ø 15,5 cm - Th. 1 cm - Weight: ± 130 g



🌿 045564

12 Moulds "Avent" for 12 pieces 19,6 x 16,5 cm
Th. 0,7 cm - Weight: ± 220 g

(070281 - Gifts + 087021 - Balls
"Baroque" + 009842 - Moulds
"Traîneau")



 **009842**

6 Moulds "Traîneau" for 2 pieces 21 x 10,5 cm - H. 13 cm
Weight: ± 300 g (see instructions on our website)



KITS



🌿 010208
8 Moulds "Père Noël bonnet"
for 4 pieces 6 x 5,8 cm
Weight: ± 45 g

These moulds are neutral.



🌿 074318
15 Moulds "Boules de Noël"
for 15 pieces 5 designs 5 x 5,8 cm
Th. 2,5 cm - Weight: ± 20 g

This mould is neutral.

JULIEN
Bouttonnet



🌿 070581
9 Moulds "Père Noël et sa hotte" for
4 pieces 7,7 x 15 cm - Th. 5,7 cm
Weight: ± 100 g



🌿 060209
10 Moulds "Ours frileux"
for 5 pieces - 9 x 15 cm - Th. 6 cm
Weight: ± 90 g



🌿 074316
12 Moulds "Père Noël Slave"
for 6 pieces - 12,7 x 13 cm - Th. 7,5 cm
Weight: ± 120 g

This mould is neutral.



🌿 074311
12 Moulds "Casse Noisette"
for 6 pieces - 6 x 17 cm - Th. 5,2 cm
Weight: ± 70 g

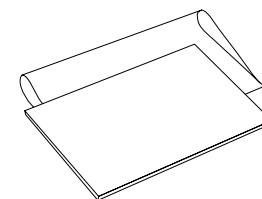

BLISTERS
PUZZLESEE INSTRUCTIONS
ON OUR WEBSITE

004428
10 Packing boxes for puzzles
(support cardbox and bags)



074248 ●●●●●
10 Blisters puzzle "Hansel" 19 x 13 cm - Weight: ± 100 g - N/A: China, Japan, UAE, Saudi Arabia, Qatar, Kuwait, Bahrain, Oman,



074249 ●●●●●
10 Blisters puzzle "Family" 19 x 13 cm - Weight: ± 100 g - N/A: China, Japan, UAE, Saudi Arabia, Qatar, Kuwait, Bahrain, Oman



070237 ●●●●●
10 Blisters puzzle "Cher Père Noël" 19 x 13 cm - Weight: ± 100 g •
N/A: UAE, Saudi Arabia, Qatar, Kuwait, Bahrain, Oman



NEW 087171 ●●●●●
10 Blisters puzzles "Rock'N'Noël" 19 x 13 cm - Weight: ± 100 g
N/A: USA, China, Japan, UAE, Saudi Arabia, Qatar, Kuwait, Bahrain, Oman, South Korea, Singapore



NEW 087172 ●●●●●
10 Blisters puzzles "La fine équipe" 19 x 13 cm - Weight: ± 100 g
N/A: USA, China, Japan, UAE, Saudi Arabia, Qatar, Kuwait, Bahrain, Oman, South Korea, Singapore



NEW 088066 ●●●●●
10 Blisters puzzles "Bande de casse-noisette" 19 x 13 cm - Weight: ± 100 g
N/A: China, Japan, UAE, Saudi Arabia, Qatar, Kuwait, Bahrain, Oman, Singapore

NEW 088067

9 Blisters lollipops "Père Noël déjanté" and sticks
for 45 prints 3 designs ø 5,4 cm
Weight: ± 15 g - N/A: China, Japan, UAE, Saudi Arabia,
Qatar, Kuwait, Bahrain, Oman





070018 ●●●●●

9 Blisters lollipops "Noël" and sticks for 45 prints 5 designs ø 5,4 cm • N/A: UAE, Saudi Arabia, Qatar, Kuwait, Bahrain, Oman



KITS

070022 ●●●●●

9 Blisters lollipops "Pingouins" and sticks for 45 prints 5 designs ± 5 cm Weight: ± 15 g • N/A: UAE, Saudi Arabia, Qatar, Kuwait, Bahrain, Oman



061247 ●●●●●

9 Blisters lollipops "Candy" and sticks for 27 prints ø 7,4 cm - N/A: China, Japan



074290 ●●●●●

9 Blisters lollipops "Boule à neige" and sticks for 45 prints 3 designs 5 x 6 cm Weight: ± 15 g - N/A: USA, China, Japan, UAE, Saudi Arabia, Qatar, Kuwait, Bahrain, Oman, South Korea



087051 ●●●●●

9 Blisters lollipops "Pains d'épices" and sticks for 45 prints 5 designs H. 6 cm Weight: ± 15 g - N/A: China, Japan, Hong Kong

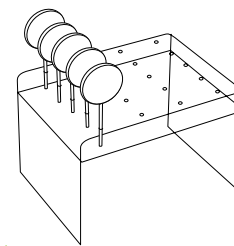

004478



500 Sticks Lollipop birch 9 x 0,38 cm



004560



Display for lollipops for 20 pieces 25 x 18 cm - H. 16,5 cm



070186 ●●●●●

9 Blisters lollipops "Père Noël" and sticks for 45 prints 5 designs ø 5,4 cm • N/A: UAE, Saudi Arabia, Qatar, Kuwait, Bahrain, Oman



074202 ●●●●●

9 Blisters lollipops "Père Noël" and sticks for 45 prints 3 designs H. ± 7 cm - Weight: ± 15 g - N/A: USA, China, Japan, UAE, Saudi Arabia, Qatar, Kuwait, Bahrain, Oman, South Korea, Singapore



002138

50 Bags for Lollipops



Free of colouring



Worldwide • Azo



Usable chocolates



TRANSFER SHEETS & MOULDS FOR MUGS

Mugs dimensions: ø 8 cm - H. 10 cm - Weight: ± 75 g

**087003** ● ● ●

10 Transfer sheets "Carrousel" for mugs 25,3 x 11 cm
 N/A: USA, China, Japan, UAE, Saudi Arabia, Qatar, Kuwait,
 Bahrain, Oman, South Korea, Singapore

**NEW 088068** ● ● ●

10 Transfer sheets "Les jouets" for mugs 25,3 x 11 cm
 N/A: China, Japan, Hong Kong, Singapore

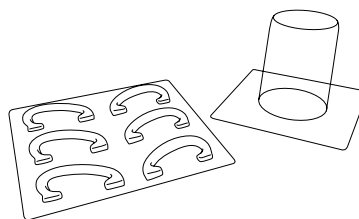
**025191**

4 Moulds "Mugs et anses" for 3 pieces
 ø 8 cm - H. 10 cm - Weight: ± 75 g

SEE INSTRUCTIONS
ON OUR WEBSITE

TRANSFER SHEETS & MOULDS FOR CONES

Cone dimensions: ø 11 cm - H. 13 cm - Weight: ± 55 g

**070326** ● ● ●

10 Transfer sheets "Père Noël" for cones 25,5 x 13,6 cm 2 designs - N/A: USA, China,
 Singapore

**NEW 088071**

10 Transfer sheets "Les oursins" for cones 25,5 x 13,6 cm 2 designs - N/A: USA,
 China, Japan, UAE, Saudi Arabia, Qatar, Kuwait, Bahrain, Oman, South Korea

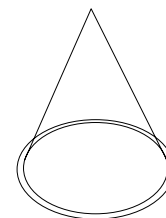
**009884**

5 Moulds "Grands cônes"
 ø 11 cm - H. 13 cm
 Weight: ± 55 g

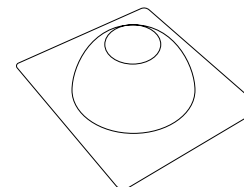
**070421**

10 Moulds "Dessous de
 bonbonnière" ø 9 cm - Th. 4 cm



TRANSFER SHEETS & MOULDS FOR SMARTPHONES

Smartphones dimensions: 6,1 x 11,6 cm - Weight: ± 47 g



087004 ● ● ●
12 Transfer sheets for smartphones
"Pingu" - N/A: USA, China, Japan, UAE,
Saudi Arabia, Qatar, Kuwait, Bahrain, Oman,
South Korea

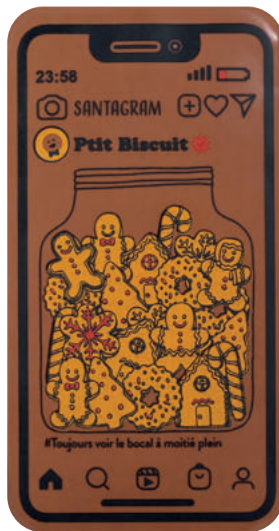

NEW 088069
12 Transfer sheets for smartphones
"P'tit biscuit" - N/A: China, Japan,
Singapore



NEW 088070
12 Transfer sheets for smartphones
"Meilleur compagnon" - N/A: USA,
China, Japan, UAE, Saudi Arabia, Qatar,
Kuwait, Bahrain, Oman, South Korea,
Singapore



SEE INSTRUCTIONS
(SAME AS CARDS)
ON OUR WEBSITE

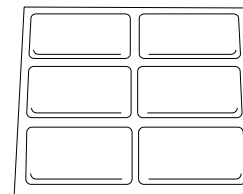

045558
2 Moulds smartphones for 12 pieces
6,5 x 12 cm - Th. 0,6 cm - Weight: ± 47 g

Free of colouring ● Worldwide ● Azo ● ● ● ● Usable chocolates

TRANSFER SHEETS & MOULDS FOR CARDS

Cards dimensions: 21 x 10,5 cm - H. 0,5 cm - Weight: ± 110 g



074251 ● ● ● ● ●

30 Transfer sheets "Happy Holidays" for cards and bags - N/A: China, Japan, UAE, Saudi Arabia, Qatar, Kuwait, Bahrain, Oman



NEW 088072

30 Transfer sheets "Pingouins joyeux" for cards and bags - N/A: USA, China, Japan, UAE, Saudi Arabia, Qatar, Kuwait, Bahrain, Oman, South Korea, Hong Kong

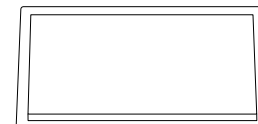

010144

10 Moulds "Cartes"
Dimensions: 21 x 10,5 - H. 0,5 cm
Weight: ± 110 g

TRANSFER SHEETS & MOULDS FOR SQUARE CARDS

Square cards dimensions: 12 x 12 cm - H. 0,5 cm - Weight: ± 65 g



070324 ● ● ● ● ●

24 Transfer sheets "Nature hivernale" for square cards and bags - N/A: USA, China, Japan, UAE, Saudi Arabia, Qatar, Kuwait, Bahrain, Oman, South Korea

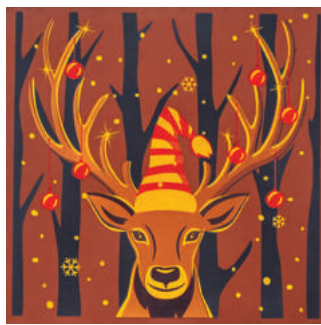

070325 ● ● ● ● ●

24 Transfer sheets "Renne de Noël" for square cards and bags
N/A: China, Japan, Singapore

NEW 088073

24 Transfer sheets "Au pied du sapin" for square cards and bags - N/A: China, Japan, UAE, Saudi Arabia, Qatar, Kuwait, Bahrain, Oman, Singapore

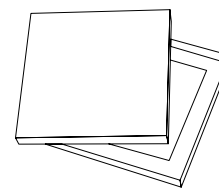

004429

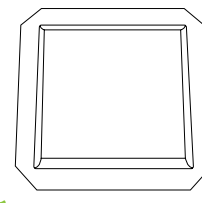
12 Packing boxes for square cards
12 Boxes, 12 blisters, 48 paddings
and 12 protective films

009961

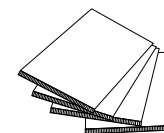
12 Moulds "Cartes carrées"
Dimensions: 12 x 12 cm
H. 0,5 cm - Weight: ± 65 g

004432

100 bags for square cards

INDIVIDUAL ENTREMETS MOULDS

Reusable and **freezable**, these moulds allow you to remove your desserts with ease. We have in fact designed a "support jamb" around most of our reusable moulds which you can for hot water into in order to remove your desserts more easily.

CLAIRE
Heitzler

🌱 087015

22 Entremets moulds "Sapin" for 36 pieces

Top: 8,75 x 11,2 cm - H. 2,4 cm

Moulds with support jambs

Bottom: 8,97 x 11,4 cm - H. 0,5 cm

Moulds without support jambs

ENTREMETS MOULDS



🌿 070527
30 Entremets moulds "Igloo"
for 120 pieces 8 x 8,6 cm - H. 3,7 cm
Moulds with support jams



🌿 070525
30 Entremets moulds
"Bonnet de Père Noël" for 120 pieces
ø 7 cm - H. 5,2 cm - Moulds with support jams



🌿 074233
30 Entremets moulds "Étoile"
for 180 pieces 8 x 7,6 cm - H. 4 cm
Moulds with support jams



🌿 070545
30 Entremets moulds
"Champagne" for 90 pieces
5,8 x 13,5 cm - H. 3 cm
Moulds with support jams



🌿 070575
10 Entremets moulds
"Bûchette rondin" 54 x 3,8 cm - H. 3,8 cm
Moulds with support jams



🌿 045841
10 Entremets moulds
"Mini-bûchette" 54 x 3,8 cm - H. 3,8 cm
🌿 048002
100 Rhodoïde sheets neutral 52,7 x 9,5 cm
to insert into the mould 045841

ENTREMETS MOULDS

 **NEW** 088248

30 Entremets Moulds "Ourson"
for 30 pieces 13,1 x 22,3 cm - H. 6,65 cm
Moulds with support jams

CHRISTOPHE
Michalak

ENTREMETS MOULDS

VINCENT

Guerlais



🌱 070528

30 Entremets moulds "Igloo"
for 30 pieces 19,5 x 21 cm - H. 9 cm
Moulds with support jams

JEAN-MICHEL

Perruchon



🌱 070524

30 Entremets moulds "Bonnet de Noël"
for 30 pieces ø 18 cm - H. 15 cm

CLAIRE

Heitzler



🌱 087016

45 Entremets moulds "Sapin" for 30 pieces
Top: 17,7 x 22,6 cm - H. 4,5 cm - Moulds with support jams
Bottom: 18,2 x 23,2 cm - H. 0,5 cm
Moulds without support jams

CLAIRE

Heitzler



🌱 **NEW** 088191

60 Entremets moulds "Couronne" for 30 pieces
Top: ø 21,9 cm - H. 2,3 cm
Bottom: ø 22,3 cm - H. 0,8 cm

🌱 065313

10 Entremets moulds
"Sphère" to clip for
5 pieces ø 12 cm - H. 10 cm

🌱 065122

2 Blisters "Attaches-boules"
so 80 prints
ø 3 cm - H. 0,8 cm

YULE LOG MOULDS

087068

10 Yule log moulds "Dessus plat"

54 x 8 cm - H. 6,5 cm

Moulds with support jambs

ÉTIENNE

Leroy



YULE LOG MOULDS



🌿 070539
30 Moulds Top of yule log "Rondin"
for 30 pieces 23,6 x 6,6 cm - H. 3,5 cm
Moulds with support jamba

🌿 070538
30 Moulds "Dessous de bûches"
for 30 pieces 24 x 7 cm - H. 4 cm



🌿 070532
30 Moulds Top of yule log "Marquise"
for 30 pieces 23,6 x 6,6 cm - H. 2 cm
Moulds with support jamba

🌿 070538
30 Moulds "Dessous de bûches"
for 30 pieces 24 x 7 cm - H. 4 cm



🌿 070533
30 Moulds Top of yule log "Duchesse"
for 30 pieces 23,6 x 6,6 cm - H. 3 cm
Moulds with support jamba

🌿 070538
30 Moulds "Dessous de bûches"
for 30 pieces 24 x 7 cm - H. 4 cm



🌿 070540
30 Moulds Top of yule log "Éminence"
for 30 pieces 23,6 x 6,6 cm - H. 2,5 cm
Moulds with support jamba

🌿 070538
30 Moulds "Dessous de bûches"
for 30 pieces 24 x 7 cm - H. 4 cm



SEE THE COMPLETE LINE OF MOULDS P. 314



JÉRÔME

De Oliveira

🌱 074241

30 Yule log moulds "Stylo" for 15 pieces
37,8 x 7,1 cm - H. 6 cm
Moulds with support jams

🌱 074242

10 Moulds "Accessoires Bûche Stylo"
for 30 pieces 12 x 3,8 cm
13,5 x 2,3 cm
Moulds with support jams



🌱 074237

30 Moulds entremets "Lingot 24 cm"
for 30 pieces
24 x 8 cm - H. 5,5 cm
Moulds with support jams

🌱 074238

30 Moulds entremets "Lingot 16 cm"
for 30 pieces
16 x 8 cm - H. 5,5 cm
Moulds with support jams



🌱 065147

10 Yule log moulds "Ooreka" 54 x 8 cm
H. 6,5 cm - Moulds with support jams



🌱 074240

30 Yule log moulds "Arrondie"
for 30 pieces 20 x 8 cm - H. 7 cm
Moulds with support jams



🌱 074244

10 Yule log moulds "Rectangle arrondi"
54 x 8 cm - H. 6,5 cm
Moulds with support jams

YULE LOG MOULDS



000366

4 Yule log moulds "Boules"
51 x 8 cm - H. 6,5 cm
Moulds with support jambs



070574

10 Yule log moulds "Fond plat"
54 x 8 cm - H. 6,5 cm
Moulds with support jambs



060232

10 Yule log moulds "Montagne"
54 x 7 cm - H. 8 cm
Moulds with support jambs



060233

10 Yule log moulds "Ondes"
54 x 8 cm - H. 6,5 cm
Moulds with support jambs

ANGELO

Musa



009922

1 Inox mould "Bûche carrée"
50 x 7 cm - H. 7 cm



070573

10 Yule log moulds "Facettes"
54 x 8 cm - H. 6,5 cm
Moulds with support jambs

YULE LOG MOULDS



🌿 070544
30 Yule log moulds "Nuage"
for 30 pieces 20 x 11 cm - H. 7 cm
Moulds with support jambs

YANN
Brys



🌿 070571
30 Yule log moulds "Mont blanc" for
15 pieces - Top: 22,8 x 6 cm - H. 2,8 cm
Moulds with support jambs
Bottom: 25 x 8 cm - H. 4,5 cm



🌿 070519
30 Yule log moulds "Trésor"
for 30 pieces 20 x 8 cm - H. 7,2 cm
Moulds with support jambs

VINCENT
Guerlais



🌿 070526
30 Yule log moulds "Champagne"
for 30 pieces 25 x 9 cm - H. 5,6 cm
Moulds with support jambs



🌿 074239
30 Classic yule log moulds "6 parts"
for 30 pieces 18 x 8 cm - H. 6,5 cm
Moulds with support jambs

CHRISTOPHE
Michalak



🌿 009992
1 Yule log mould "Tube"
50 cm ø 6,4 cm and 2 covers
🌿 005019
100 Rhodoide sheets neutral 50 x 21 cm



🌀 070587

10 Yule log moulds "Standard"
54 x 8 cm - H. 6,5 cm

🌀 048001

100 Rhodoïde sheets neutral
52,7 x 17,7 cm to insert
into the mould 070587

🌀 060234

10 Moulds "Petite bûche gouttière"
54 x 5,7 cm - H. 5 cm

🌀 060235

100 Rhodoïde sheets neutral 52,7 x 12,7 cm
to insert into the mould 060234

🌀 045841

10 Moulds "Mini-bûchette" 54 x 3,8 cm

🌀 048002

100 Rhodoïde sheets neutral 52,7 x 9,5 cm
to insert into the mould 045841

STRUCTURE SHEETS FOR YULE LOG



(087107 - Blisters "Pomme de pin"
+ 060153 - Structure sheets
"Mouvance" for yule log + 070587
Yule log moulds "Standard")

ENTREMETS



🌿 060156
10 Structure sheets "Petit Matelassé"
for yule log 52,7 x 17,7 cm



🌿 060153
10 Structure sheets "Mouvance" for yule log
52,7 x 17,7 cm

These structure sheets have been specially created to be used with our moulds "Cadre pâtissier" (070584-074072-074073 P. 248) and moulds "Standard Yule log" (070587 P. 105).



SEE INSTRUCTIONS
ON OUR WEBSITE



🌿 060154
10 Structure sheets "Ananas" for yule log
52,7 x 17,7 cm



🌿 065066
10 Structure sheets "Envol" for yule log
52,7 x 17,7 cm



🌿 065067
10 Structure sheets "Écorce" for yule log
52,7 x 17,7 cm



🌿 060152
10 Structure sheets "Déstructuré" for yule log
52,7 x 17,7 cm



🌿 065068
10 Structure sheets "Pyramide" for yule log
52,7 x 17,7 cm



🌿 060155
10 Structure sheets "Bulles" for yule log
52,7 x 17,7 cm

I love you



DECORATIONS



061016
135 Hearts White choc "Love" 3 cm
N/A: China, Singapore



061394
165 Hearts Compound 2 x 1,7 cm
N/A: China, Japan

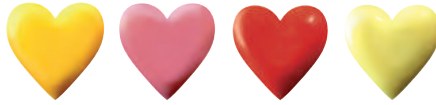

061275
266 Mini Hearts White choc 4 designs 1,3 x 1,3 cm
N/A: USA, China, Japan, UAE, Saudi Arabia, Qatar, Kuwait, Bahrain, Oman, Hong Kong

VALENTINE'S DAY



087052
135 Hearts White choc "Kelsch" 5 designs 3 cm - N/A: China, Japan



008630
Hearts Dark choc shiny bronze
1,4 x 1,38 cm - 200 g - N/A: USA, China, Japan, UAE, Saudi Arabia, Qatar, Kuwait, Bahrain, Oman, South Korea



061274
40 Hearts White Choc "Love" 4,8 x 4,5 cm
N/A: China, Japan



NEW 087128
80 Decorations White Choc "Graffiti" 4,7 x 4,3 cm
N/A: USA, China, Japan, South Korea



074278
140 Wax seals "Cœur" compound 2 designs ø 3,5 cm - N/A: Hong Kong



NEW 087127
50 Envelopes White Choc "I love You" 4,85 x 5,8 cm
N/A: China, Japan



087048
66 Rectangles White choc "Be my Valentine" 2 designs 4 x 2,9 cm
N/A: China, Japan



087006
100 Stamps White choc "Love"
3,3 x 4,5 cm - N/A: China, Japan

DECORATIONS



NEW 088076
140 Rectangles White Choc "Declaration"
4 x 2 cm - N/A: China, Japan



NEW 088074
110 Rectangles White Choc "Love" 7 x 2 cm - N/A: China, Japan, Hong Kong



NEW 088075
88 Squares White Choc "Love you" 3 cm - N/A: China, Japan, Hong Kong



061276
190 Mini lips
Compound 2 designs
2 x 1,45 cm - N/A:
China, Japan, UAE, Saudi
Arabia, Qatar, Kuwait,
Bahrain, Oman



NEW 088077
300 Hearts White Choc "Mots d'amour" 6 designs 2 x 1,7 cm - N/A: China, Japan, Hong Kong



061277
65 Lips Compound 2 designs 4,3 x 2,5 cm
N/A: China, Japan



NEW 087101
100 Hearts White choc embossed "Je t'aime" 5,85 x 5,4 cm



074335
Sugar hearts shiny ruby 0,6 cm - 200 g
N/A: USA, Canada, China, Japan, South Korea, Taiwan



061332 "Amour" ●●●●
17 Transfer sheets 40 x 25 cm - N/A: China, Japan

DECORATIONS

FLORENT
Margaillan



025192

2 Moulds "Tablette Cœurs" for 8 pieces
15,5 x 6,2 cm - Weight: ± 70 g



070422

10 Moulds "Tablette French Kiss"
7,8 x 12,2 cm - 6,8 x 10,2 cm
Th. 2 cm - Weight: ± 180 g



070238

9 Blisters lollipops "Bouche" and sticks for 36 prints
6,5 x 3,8 cm - Weight: ± 16 g



NEW 087164 ●●●

4 Moulds "Que du love" for 8 pieces 10 x 10 cm
H. 1,5 cm - Weight: ± 60 g - N/A: USA, China, Japan,
Qatar, South Korea



NEW 087180 ●●●

10 Transfer sheets "Je t'aime" for mugs
25,3 x 11 cm - N/A: USA, China, Japan,
UAE, Saudi Arabia, Qatar, Kuwait, Bahrain,
Oman, South Korea

025191

4 Moulds "Mugs et anses" for
3 pieces ø 8 cm - H. 10 cm
Weight: ± 75 g

MOTHER & FATHER'S DAYS



NEW 088078
150 Whiskers Choc BC "Happy Father's day"
4,8 x 1,5 cm



087022
120 Hearts White choc "Happy Mother's day" 5 x 4,7 cm
N/A: China, Japan



074252
100 Hearts White choc "Happy Mother's day" 5,8 x 5,4 cm
N/A: China, Japan



070473
120 Squares White choc "I Love Mum" 2 designs 3,5 cm • N/A: UAE, Saudi Arabia, Qatar, Kuwait, Bahrain, Oman



NEW 088080
63 Wax seals "Happy Mother's day"
Compound ø 3,5 cm - N/A: China, Japan, Hong Kong



NEW 088079
63 Wax seals "Happy Father's day"
Compound ø 3,5 cm



070110
100 Diamonds White choc "Super papa" 4 x 3,5 cm • N/A: UAE, Saudi Arabia, Qatar, Kuwait, Bahrain, Oman



070474
120 Squares White choc "I Love Dad" 2 designs 3,5 cm • N/A: UAE, Saudi Arabia, Qatar, Kuwait, Bahrain, Oman



070465
120 Squares White choc "Mom"
4 cm • N/A: UAE, Saudi Arabia, Qatar, Kuwait, Bahrain, Oman



087054
120 Squares White choc "Mother's Day" 2 Designs 3,5 cm - N/A: China, Japan, Singapore





ENTREMETS MOULDS

FRÉDÉRIC

Cassel



🌱 070516

30 Entremets moulds "Cœur matelassé"
for 30 pieces 14,5 x 14,5 cm - H. 3,5 cm
Moulds with support jambs

🌱 070512

30 Entremets moulds "Cœur spirale"
for 30 pieces 17,3 x 17,8 cm - H. 5 cm
Moulds with support jambs

JEAN-PIERRE

Rodrigues



🌱 074070

30 Entremets moulds "Cœur diamant"
for 30 pieces 14,5 x 14,5 cm - H. 4 cm
Moulds with support jambs

ARNAUD

Lahrer



🌱 074069

30 Entremets moulds "Bouche for 2"
for 60 pieces 14,3 x 8,3 cm - H. 4 cm
Moulds with support jambs

🌱 074067

30 Entremets moulds "Bouche"
for 30 pieces 20 x 12 cm - H. 5 cm
Moulds with support jambs

ÉTIENNE

Leroy



🌱 087017

30 Entremets moulds "Cœur" for 60 pieces
11,2 x 11,8 cm - H. 3,8 cm
Moulds with support jambs

ÉTIENNE

Leroy



🌱 074066

30 Entremets moulds "Cœur drapé"
for 30 pieces 15,1 x 13,3 cm - H. 6,4 cm
Moulds with support jambs



SEE THE COMPLETE
LINE OF MOULDS P. 310



070515

30 Individual Entremets moulds "Cœur spirale"
for 120 pieces 8,4 x 8 cm - H. 3,3 cm
Moulds with support jamba

PHILIPPE

Rigollot



070548

30 Individual Entremets moulds
"Pomme" for 60 pieces
Top ø 7,4 cm - H. 2,6 cm
Moulds with support jamba
Bottom ø 7,4 cm - H. 3,7 cm
Moulds with support jamba

CÉDRIC

Grolet



074062

30 Individual Entremets moulds "Double cœur"
for 240 pieces (so 120 entremets) 5 x 8,7 cm
5,4 x 9,4 cm - H. 4,5 cm
Moulds with support jamba

ÉTIENNE

Leroy



074063

30 Individual Entremets moulds "Cœur drapé"
for 120 pieces 8,5 x 7,5 cm - H. 3,8 cm
Moulds with support jamba



074061

30 Individual Entremets moulds "Bouche"
for 180 pieces 9,5 x 5,6 cm - H. 3,5 cm
Moulds with support jamba



074060

30 Individual Entremets moulds "Petite tarte
rose" for 120 pieces ø 7,4 cm - H. 2 cm

070536

30 Individual Entremets moulds "Palet"
for 150 pieces ø 8 cm - H. 1,7 cm
Moulds with support jamba

(087053 - Sticks "Lignes"
+ 070421 - Moulds "Dessous
de bonbonnière" + 088134
Cats "Kawaii")



DECORATIONS



070250
88 Squares Compound "Signe Chinois"
3 cm • N/A: UAE, Saudi Arabia, Qatar, Kuwait,
Bahrain, Oman



070278
176 Rounds Compound
"Symbole" ø 3 cm • N/A: UAE,
Saudi Arabia, Qatar, Kuwait, Bahrain,
Oman



087035
140 Chinese coins Compound
ø 3,2 cm - N/A: China, Japan, Hong
Kong



087045
72 Mini-cats White choc "Maneki" 2,4 x 3,35 cm
N/A: China, Japan, Hong Kong



070341
210 Mini-lanterns White choc "Fête de la lumière"
3 designs • N/A: Canada, China, UAE, Saudi Arabia, Qatar,
Kuwait, Bahrain, Oman, South Korea



070364
192 Peanuts Choc BC 4 x 1,75 cm



087049
96 Banners White choc "Nouvel an" 6 x 2,7 cm - N/A: China,
Japan, Hong Kong



070303 "Sérénité" ●●●●●
17 Transfer sheets 40 x 25 cm • N/A: UAE, Saudi Arabia, Qatar, Kuwait, Bahrain,
Oman



NEW **088018** "Wagara" ●●●●●
17 Transfer sheets 40 x 25 cm - N/A: USA, China, Japan, UAE, Saudi Arabia,
Qatar, Kuwait, Bahrain, Oman, South Korea, Hong Kong



070384
176 Cherry blossoms White choc "Sakura" 2 designs • N/A: China,
UAE, Saudi Arabia, Qatar, Kuwait, Bahrain, Oman



070363
176 Cherry blossoms Compound "Rose" 3 cm • N/A: China, UAE, Saudi
Arabia, Qatar, Kuwait, Bahrain, Oman



NEW **088134**
150 Cats White choc "Kawaii" 3 designs 2,7 x 3,1 cm - N/A:
UAE, Saudi Arabia, Qatar, Kuwait, Bahrain, Oman

Free of colouring Worldwide • Azo

(074293 - Rectangles "Happy Easter"
+ 074125 - Moulds "Kit Œufs")



HAPPY EASTER



003779
288 Eggs Dark choc "Scintillant" 6 designs - 2,7 x 4 cm
N/A: USA, China, Japan, UAE, Saudi Arabia, Qatar, Kuwait, Bahrain, Oman, South Korea



087023
288 Eggs Dark choc "Kermesse" 3 designs - 2,7 x 4 cm
N/A: USA, China, Japan, UAE, Saudi Arabia, Qatar, Kuwait, Bahrain, Oman, South Korea



061064
288 Eggs Dark choc "Joyaux" 3 designs - 2,7 x 4 cm
N/A: USA, China, Japan, UAE, Saudi Arabia, Qatar, Kuwait, Bahrain, Oman, South Korea



NEW 088083
288 Eggs Milk choc "Paisley" 3 designs - 2,7 x 4 cm - N/A: USA, China, Japan, UAE, Saudi Arabia, Qatar, Kuwait, Bahrain, Oman, South Korea



070029
288 Eggs White choc "Nuances" 3 designs - 2,7 x 4 cm •
N/A: UAE, Saudi Arabia, Qatar, Kuwait, Bahrain, Oman



074058
288 Eggs White choc "Pop" 4 designs 2,7 x 4 cm - N/A: USA, China, Japan, Hong Kong



NEW 088082
288 Eggs White choc "Woodstock" 3 designs - 2,7 x 4 cm - N/A: China, Japan, Hong Kong



NEW 088081
288 Eggs White choc "Marguerite" 3 designs - 2,7 x 4 cm - N/A: China, Japan, Hong Kong



019168
63 Eggs White choc crystallized bronze 2,3 X 3,4 cm - N/A: USA, China, Japan, Qatar, South Korea

DECORATIONS

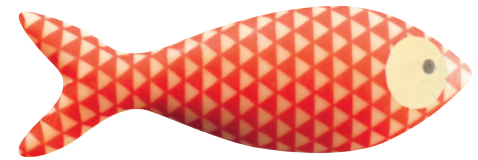
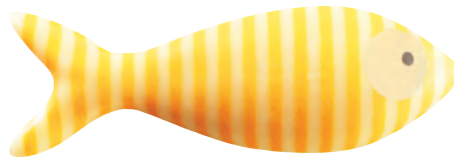
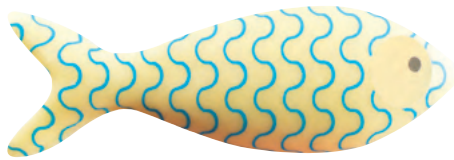

070089

112 Sardines White choc "En bande" 3 designs 6 x 2 cm •
N/A: UAE, Saudi Arabia, Qatar, Kuwait, Bahrain, Oman



070087

252 Mini-rabbits White choc 6 designs 1,9 x 2,5 cm • N/A: China, Japan, UAE, Saudi Arabia, Qatar, Kuwait, Bahrain, Oman

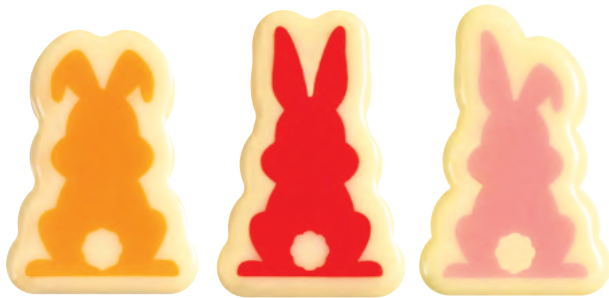

NEW 088127

144 Rabbits White choc "Le trio" 3 designs - N/A: China, Japan, UAE, Saudi Arabia, Qatar, Kuwait, Bahrain, Oman, Hong Kong

NEW 061170

70 Hens White choc 3,1 x 3,5 cm
N/A: USA, China, Japan

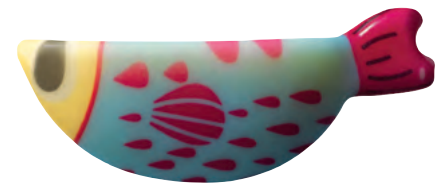
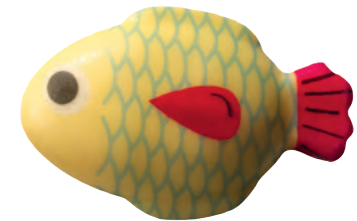

070090

90 Rabbits White choc "Endimanchés" 2 designs • N/A: UAE, Saudi Arabia, Qatar, Kuwait, Bahrain, Oman



NEW 088084

70 Eggs White Choc "Be happy" 2 designs
N/A: USA, China, Japan, Hong Kong

NEW 088231

96 Fishes White Choc "La bande à Maurice" 5 designs
N/A: USA, China, Japan, South Korea





DECORATIONS



061069

154 Eggs White choc 3 designs - N/A: China, UAE, Saudi Arabia, Qatar, Kuwait, Bahrain, Oman



NEW 088230

140 Hens White Choc "Gallinacés" 2 designs 3D 3,2 x 2,96 cm
N/A: USA, China, Japan, Qatar, South Korea



NEW 088140

125 Carrots White choc "Crazy carrot" 1,6 x 5,4 cm
N/A: USA, China, Japan, UAE, Saudi Arabia, Qatar, Kuwait, Bahrain, Oman, South Korea, Hong Kong

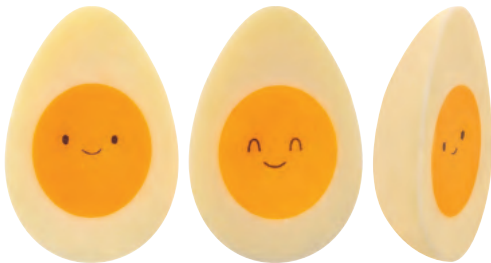

NEW 088085

126 Half-shells Eggs White Choc "Tête d'œuf" 2 designs
2,3 x 3,4 cm - N/A: China, Japan, South Korea, Hong Kong



NEW 088129

120 Eggs White choc "Silhouettes" 3 designs 2,2 x 3 cm - N/A: USA, China, Japan, UAE, Saudi Arabia, Qatar, Kuwait, Bahrain, Oman, Hong Kong



087046

114 Carrots White choc 2 designs
1,6 x 4,1 cm - N/A: China, Japan, Hong Kong

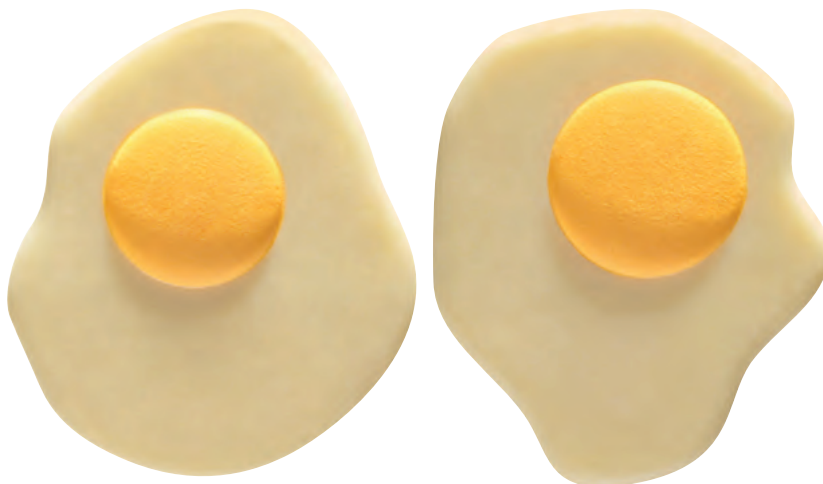

087067

48 Fried eggs White choc 2 designs - N/A: USA, China, Japan, South Korea

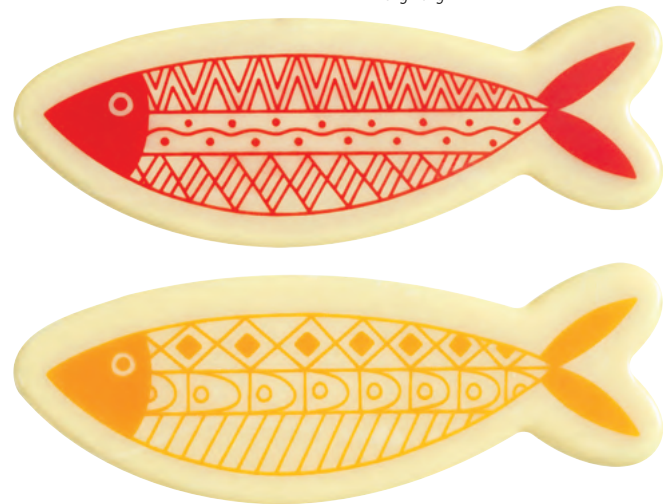

NEW 088128

66 Fishes White choc "Azteques" 3 designs 8,5 x 3,1 cm - N/A: USA, China, Japan, UAE, Saudi Arabia, Qatar, Kuwait, Bahrain, Oman, Hong Kong

DECORATIONS



070169
135 Rabbit ears White choc
1,6 x 7 cm



070172
70 Rabbit ears White choc 4 x 4,6 cm •
N/A: UAE, Saudi Arabia, Qatar, Kuwait,
Bahrain, Oman



004886
70 Rabbit ears Milk choc 4 x 4,6 cm

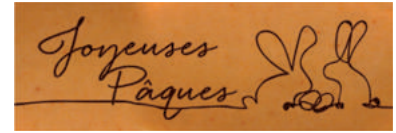

070168
120 Rectangles Choc BC "Linea" 5 x 1,7 cm



074293
110 Rectangles Dark choc "Happy Easter" 7 x 2 cm - N/A: China



NEW 088137
150 Rabbits White choc "Garenne" 5 designs

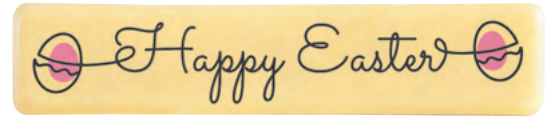

074294
140 Rectangles White choc "Happy Easter" 7 x 1,5 cm - N/A: Hong Kong



070167
144 Rabbit snouts White choc 3 cm



060907
180 Hens White choc 4 designs - N/A: USA, China



087024
180 Rabbits White choc "Le quatuor" 2 x 3 cm
4 designs - N/A: USA, China, Japan, UAE, Saudi Arabia, Qatar, Kuwait, Bahrain, Oman, South Korea



NEW 088088
75 Rectangles Dark Choc "Happy Easter" 5 x 3,3 cm
N/A: USA, China, Japan, UAE, Saudi Arabia, Qatar, Kuwait,
Bahrain, Oman, South Korea



NEW 074138
112 Sardines Choc BC 2 designs 6 x 2 cm



070176 ●●●

9 Blisters lollipops "Lapin" and sticks for 45 prints
H. 5,7 cm - 5 designs - Weight: \pm 15 g • N/A: UAE, Saudi
Arabia, Qatar, Kuwait, Bahrain, Oman



KITS



NEW 074196 ●●●●
 12 Moulds "Spider Lapin" for
 6 pieces 8,8 x 15 cm - Weight: ± 90 g
 N/A: USA, China, Japan, South Korea



NEW 088091 ●●●●
 12 Moulds "Floyd" for
 6 pieces 8,8 x 15 cm - Weight: ± 90 g
 N/A: USA, China, Japan, UAE, Saudi Arabia,
 Qatar, Kuwait, Bahrain, Oman, South Korea,
 Singapore



NEW 088090 ●●●●●
 12 Moulds "Batlapin" for
 6 pieces 8,8 x 15 cm - Weight: ± 90 g
 N/A: USA, China, Japan, UAE, Saudi Arabia,
 Qatar, Kuwait, Bahrain, Oman, South Korea



NEW 074145 ●●●●
 20 Moulds "Marguerite" for
 10 pieces 9,2 x 13,3 cm - Recto/verso
 Weight: ± 110 g - N/A: USA, China, Japan,
 Qatar, South Korea, Singapore



NEW 074002 ●●●●
 18 Moulds "Chaton marin" for 9 pieces
 8,5 x 13 cm - Weight: ± 100 g
 N/A: China, Japan



061227 ●●●●●
 12 Moulds "Lapin Maneki" for 6 pieces
 8 x 12 cm - Weight: ± 100 g
 N/A: China, Japan

FLORENT
Margaillan



NEW 074089

12 Moulds "Œuf Mandala" for
6 pieces 10 x 15 cm - Th. 10 cm
Weight: ± 130 g

JÉRÔME
*De
Oliveira*



NEW 074090

12 Moulds "Œuf Fleurs" for
6 pieces 10 x 15 cm - Th. 10 cm
Weight: ± 130 g



NEW 074086

12 Moulds "Œuf tissé" for
6 pieces 10 x 15 cm - Th. 10 cm
Weight: ± 130 g

JÉRÔME
Chausse



NEW 074092

12 Moulds "Œuf vague" for
6 pieces 2 designs - 8,2 x 13 cm
9,6 x 15 cm - Th. 8,2 - 9,6 cm
Weight: ± 85 g - 120 g

NICOLAS
Bernardé



NEW 010314

12 Moulds "Œufs Diamant" for 6 pieces
3 designs 21,5 x 14 cm - 14,2 x 9,4 cm
12,2 x 8 cm - Weight: ± 280 g
130 g - 90 g



NEW 074091

12 Moulds "Œuf Larme strié" for
6 pieces 8,5 x 15 cm - Th. 8,5 cm
Weight: ± 120 g

NEW 074081

12 Moulds "Œuf Larme strié" for
6 pieces 11,5 x 19 cm - Th. 11,5 cm
Weight: ± 150 g



NEW 088239

12 Moulds "Eufs textures"
for 6 pieces 9,8 x 15 cm - Th. 9,8 cm
Weight: ± 130 g





NEW 074077
12 Moulds "Euf cabosse" for 6 pieces
10,6 x 17 cm - Th. 10,6 cm
Weight: ± 120 g

JULIEN
Alvarez



These moulds can be used with
moulds 074124 (see p. 303)



NEW 074087

16 Moulds "Œuf visage Risetite" for
8 pieces 4 designs - 8,6 x 13,3 cm
Th. 9,6 cm - Weight: ± 80 g



NEW 087188

16 Moulds "Sous-marin" for 8 pieces
15 x 10,5 cm - Th. 10,5 cm
Weight: ± 100 g



NEW 074085

12 Moulds "Cloche Ding Dong" for
6 pieces 10,5 x 11 cm - Th. 10,5 cm
Weight: ± 80 g



040150

2 Moulds "Tablette Lapins" for 8 pieces
15 x 14 cm - Th. 0,7 cm
Weight: ± 100 g



074323

12 Moulds "Friture sardine" for 216
pieces 3 designs 9 x 2,2 cm
Th. 0,7 cm - Weight: ± 7 g



NEW 074327

12 Moulds "Friture Lapinou" for
432 pieces 9 designs - Th. 1 cm
Weight: ± 6 g



NEW 074098
12 Moulds "Lapin Boule" for
6 pieces 11 x 11 cm - Th. 9,2 cm
Weight: ± 100 g



NEW 074093
12 Moulds "Lapin Peluche" for
6 pieces 10,3 x 14,7 cm - Th. 7,2 cm
Weight: ± 110 g



NEW 074108
12 Moulds "Teddy lapin" for 4 pieces
Body: 8,1 x 15 cm - Arm: 1,9 x 4,2 cm
Foot: 2,4 x 4,9 cm - Th. 7 cm
Weight: ± 100 g



NEW 040153
8 Moulds lapin "Facettes" for 4 pieces
13 x 11,5 cm - Ép. 7 cm - Weight: ± 115 g



NEW 074094
12 Moulds "Lapin Moustache" for
6 pieces 8,8 x 15 cm - Th. 5,6 cm
Weight: ± 90 g



NEW 074112
20 Moulds "Petits Rabbits" for
10 pieces 8 x 8 cm - Th. 5 cm
Weight: ± 30 g

NEW 074095
12 Moulds "Rabbits" for
6 pieces 12,5 x 12,5 cm - Th. 9 cm
Weight: ± 55 g



🍴 074307

12 Moulds "Fusée" for 6 pieces
8,7 x 14,9 cm - Th. 8,8 cm
Weight: ± 90 g

🍴 074309

12 Moulds "Lapin Astronaute" for 6 pieces
9,2 x 15 cm - Th. 7,1 cm
Weight: ± 80 g

🍴 074312

12 Moulds "Mini lapin
Astronaute" for 12 pieces
5,1 x 6,7 cm - Th. 3,1 cm
Weight: ± 15 g

🍴 074313

12 Moulds "Mini Astronaute"
for 12 pieces 5,1 x 5,3 cm
Th. 3,1 cm
Weight: ± 15 g

A close-up photograph of a dark chocolate Easter bunny. The bunny is sitting upright on a clear, faceted glass pedestal. The background is a soft, out-of-focus bokeh of warm, golden and pinkish lights, suggesting a festive or celebratory setting. The bunny has two large, upright ears and a small, detailed face with a nose and closed eyes. The chocolate has a smooth, slightly glossy finish.

  **NEW 088240**

12 Moulds "Lapin dodu" for 6 pieces
7 x 12 cm - Th. 8,1 cm
Weight: ± 70 g



NEW 074083
12 Moulds "Œuf Lapin" for
6 pieces 9,3 x 15 cm - Th. 9,5 cm
Weight: ± 130 g



NEW 074082
12 Moulds "Œuf Oreille" for
6 pieces 9,5 x 19,5 cm - Th. 9,5 cm
Weight: ± 160 g

These moulds are neutral.



NEW 074319
8 Moulds "Voiture Carotte"
for 6 pieces - 17 x 5,5 cm
Th. 5,7 cm - Weight: ± 80 g

These moulds are neutral.



QUENTIN
Bailly

NEW 088250
8 Moulds "Carotte" for
8 pieces 4,2 x 15 cm - Th. 4,2 cm
Weight: ± 55 g



 **NEW 088241**
16 Moulds "La comtesse" for 8 pieces
12,4 x 14 cm - Th. 10 cm
Weight: ± 115 g



NEW 074088
12 Moulds "Les Binoclarde" for
6 pieces 2 designs - 9,8 x 14 cm
9,8 x 10,9 cm - Th. 10,3 cm - 9,6 cm
Weight: ± 150 g



NEW 074305
20 Moulds "Mouton pelote" for 10 pieces
7,7 x 8,8 cm - Th. 7,2 cm
Weight: ± 45 g



NEW 088251
24 Moulds "Joyeux trio de poulettes"
for 12 pieces 3 designs - 6,65 x 7,35 cm
6 x 8,55 cm - 6,2 x 8,7 cm - Th. ± 5 cm
Weight: ± 30 g



NEW 074123
10 Moulds "Boîte à œufs" for
10 pieces 15,5 x 10,5 cm
Th. 4 cm - Weight: ± 90 g

NEW 010328
10 Moulds "Œufs" for 30 pieces
H. 6 cm - Weight: ± 16 g



NEW 074096
12 Moulds "Poule et Coq" for
6 pieces 2 designs
12 x 14,3 cm - 11 x 18,5 cm
Th. 8 cm - 9 cm - Weight: ± 65 g - 80 g



NEW 074100
24 Moulds "Poulettes" for 12 pieces
3 designs 9,4 x 9,9 cm - 8,5 x 10 cm
10,5 x 6,5 cm - Th. 6,4 cm
Weight: ± 30 g

NEW 010187
1 Mould "Socle Poulettes"
for 15 pieces 4 x 4 cm - Weight: ± 8 g

JÉRÔME

De Oliveira

NEW 074104

12 Moulds "Hippocampe" for
6 pieces 9,8 x 13 cm - Th. 6 cm
Weight: ± 85 g



NEW 074120

16 Moulds "Boîte à sardines" for
8 pieces 11,5 x 7 cm - Th. 3,3 cm
Weight: ± 70 g

JÉRÔME

De Oliveira

NEW 074121

16 Moulds "Bord de mer" for 4 pieces 5 designs
Palms: 10 x 8 cm Th. 2,4 cm - Tubas: 4,5 x 10 cm Th. 0,7 cm
Bottles: 11 x 2,6 cm Th. 1,3 cm
Large masks: 5,5 x 3,1 cm Th. 1 cm
Small masks: 4,2 x 2,2 cm Th. 1 cm

VIANNEY

Bellanger

NEW 074078

12 Moulds "Baleine" for 6 pieces
17,5 x 8,7 cm - Th. 7,2 cm
Weight: ± 120 g



NEW 074084

16 Moulds "Poussin matelot"
for 8 pieces 4 designs
9,4 x 13 cm - 10,2 x 13 cm - 9,8 x 13 cm
Th. 7,6 cm - 7,5 cm - 8,5 cm - 8 cm
Weight: ± 120 g

QUENTIN

Bailly



NEW 074079

12 Moulds "Coquillage conque" for
6 pieces 11,3 x 15 cm - Th. 10 cm
Weight: ± 120 g

(074079 - Moulds "Coquillage conque"
+ 074125 - Moulds "Kit (Eufs
+ 061177 - Eyes "Regards Comics)

JOYEUSES
PÂQUES

H





🌿 074064

30 Individual entremets moulds "Lapinou"
for 120 pieces 10 x 8 cm - H. 4 cm
Moulds with support jambs

ARNAUD
Lahrer



🌿 074245

30 Individual entremets moulds
"Euf bombé" for 120 pieces
6 x 10 cm - H. 3 cm
Moulds with support jambs

ÉTIENNE
Leroy



🌿 074068

30 Entremets moulds "Nid"
for 30 pieces ø 14 cm - H. 2 cm
Moulds with support jambs

ARNAUD
Lahrer



🌿 074246

30 Entremets moulds "Euf bombé"
for 30 pieces 16 x 26 cm - H. 5 cm
Moulds with support jambs



🌿 074065

30 Entremets moulds "Lapin"
for 30 pieces 14,4 x 17,8 cm - H. 7 cm
Moulds with support jambs



MIDDLE EAST COLLECTION



087038
110 Drops Dark choc "Inde" 4,4 x 2,9 cm - 2 designs - N/A: China, Japan, Hong Kong



NEW 088097
88 Squares Dark Choc
"Crêpuscule" 3 cm - N/A: USA,
China, Japan, Qatar, South Korea,
Hong Kong



NEW 088096
120 Rectangles Dark Choc "Ornements" 6 x 2 cm - N/A: USA,
China, Japan, Qatar, Hong Kong



NEW 088095
96 Squares White Choc "Calligraphie" 4 cm
N/A: USA, China, Japan, Qatar, South Korea



NEW 088092
72 Rectangles White Choc "Ramadhan Kareem" 6 x 3 cm
N/A: USA, China, Japan, Qatar, South Korea



NEW 088093
66 Rectangles Dark Choc "Moucharabieh"
4 x 2,9 cm - N/A: USA, China, Japan, Qatar,
South Korea, Hong Kong



NEW 088094
96 Squares Dark Choc "Nuit d'Orient"
4 cm - N/A: USA, China, Japan, Qatar, South
Korea, Hong Kong



NEW 088008 ● ● ● ● ●
17 Transfer sheets "Paisley" 40 x 25 cm - N/A: USA, China,
Japan, Qatar, South Korea, Hong Kong

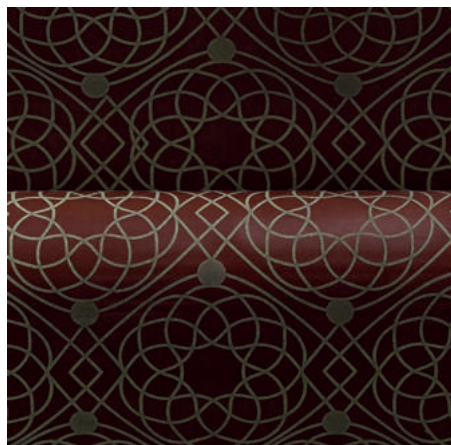

NEW 088016 ● ● ● ● ●
17 Transfer sheets "Oriental" 40 x 25 cm - N/A: Hong Kong

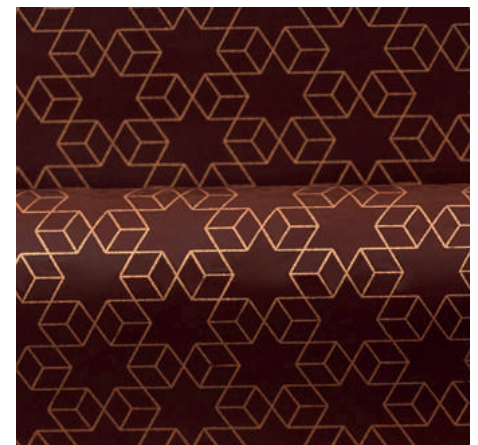

NEW 088017 ● ● ● ● ●
17 Transfer sheets "Alicatados" 40 x 25 cm - N/A: USA, China,
Japan, Qatar, South Korea



EYES & ACCESSORIES



087027
120 Oval eyes compound 3 designs
3,4 x 1,7 cm



087028
171 Oval eyes compound
3 designs 2,2 x 1,3 cm



087029
266 Oval eyes compound with
lashes 4 designs 1,3 x 0,9 cm



070039
323 Round eyes compound
"Bruns" ø 1 cm



087030
323 Round eyes
compound "Bleus" ø 1 cm



070359
182 Cartoon eyes compound
"Marron" 3,5 x 2,3 cm - N/A: UAE,
Saudi Arabia, Qatar, Kuwait, Bahrain,
Oman

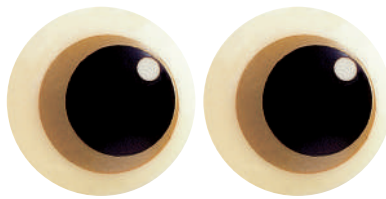

070038
108 Round eyes compound ø 2,5 cm

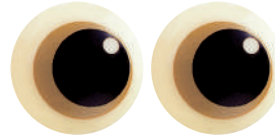

087026
165 Round eyes compound ø 1,7 cm



NEW 088136
171 Eyes White choc "Cartoon" 4 designs

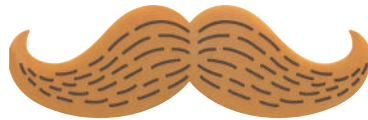
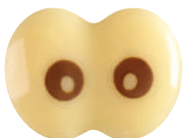

070165
150 Whiskers Choc BC 4 designs 4,8 x 1,5 cm



070163
171 Eyes White choc 4 designs

025125
72 Whiskers Dark choc 7 x 2,2 cm

061177
105 Eyes White choc "Regards Comics" 7 designs 4,4 x 3,1 cm





070503
304 Mini leaves Dark choc "Traits verts"
1,5 x 2,9 cm - N/A: UAE, Saudi Arabia, Qatar, Kuwait, Bahrain, Oman



070274
304 Mini leaves White choc "Double nervure"
1,5 x 2,9 cm - N/A: UAE, Saudi Arabia, Qatar, Kuwait, Bahrain, Oman

DECORATIONS



 **060920**
160 Curved leaves White choc 2 designs - N/A: USA, China





061263
240 Curved leaves White Choc "Vertes" - N/A: China

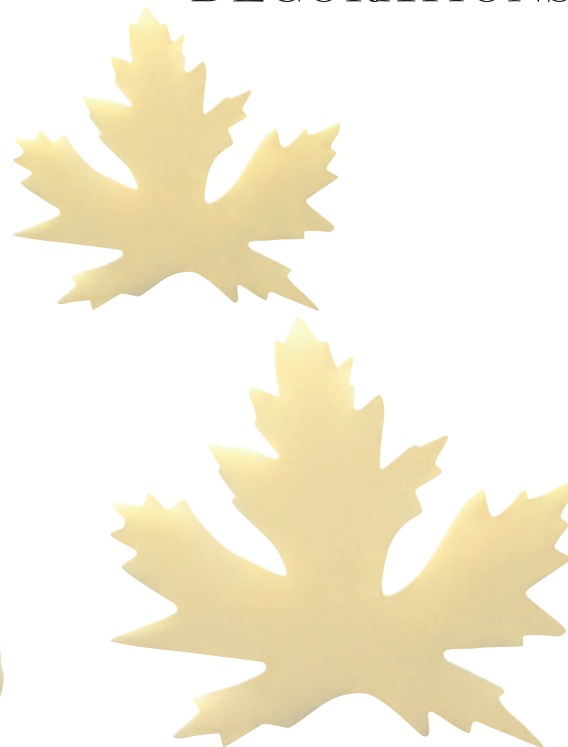

070448
300 Mini leaves White choc "Vert et or" 4 designs - N/A: USA, China, Japan, UAE, Saudi Arabia, Qatar, Kuwait, Bahrain, Oman, South Korea

"NATURE" DECORATIONS



 **070292**
100 Maple leaves White choc 2 designs - 6,1 x 5,7 cm
4,8 x 4,1 cm



070502
132 Classic leaves Dark choc "Traits verts"
2,9 x 5 cm - N/A: UAE, Saudi Arabia, Qatar, Kuwait, Bahrain, Oman



070273
132 Classic leaves White choc "Double nervure"
2,9 x 5 cm - N/A: UAE, Saudi Arabia, Qatar, Kuwait, Bahrain, Oman



070104
135 Leaves Dark choc "Traits verts"
1,6 x 7 cm - N/A: UAE, Saudi Arabia, Qatar, Kuwait, Bahrain, Oman



070272
135 Leaves White choc "Double nervure"
1,6 x 7 cm - N/A: UAE, Saudi Arabia, Qatar, Kuwait, Bahrain, Oman



NEW 088139
90 Leaves White choc "Chlorophylle"
2 designs 4,5 x 2,7 cm - N/A: USA, China, Japan, UAE, Saudi Arabia, Qatar, Kuwait, Bahrain, Oman, South Korea, Hong Kong

 Free of colouring  Worldwide • Azo



074277
110 Oak leaves Choc BC 3,1 x 5 cm



 **060264**
45 Holly leaves Barley grass
3,7 x 5,5 cm - N/A: USA, China







DECORATIONS



 **060292**
 98 Curved oak leaves Dark choc
 3 designs 2,3 x 4,7 cm - 3 x 6 cm
 3,9 x 7,8 cm

 **060291**
 98 Curved oak leaves Choc BC
 3 designs 2,3 x 4,7 cm - 3 x 6 cm
 3,9 x 7,8 cm

 **060294**
 98 Curved holly leaves Dark choc
 3 designs 2,5 x 5 cm - 3,1 x 6,3 cm
 3,7 x 7,6 cm

 **060293**
 98 Curved holly leaves Choc BC
 3 designs 2,5 x 5 cm - 3,1 x 6,3 cm
 3,7 x 7,6 cm

DECORATIONS



060911
160 Little curved feathers Choc BC 1,9 x 4 cm



004831
156 Leaves Dark choc 2 designs



070157
132 Classic leaves Dark choc "Traits or"
2,9 x 5 cm - N/A: UAE, Saudi Arabia, Qatar, Kuwait, Bahrain, Oman



045648
180 Small ribbed leaves Choc BC 4 designs



070353
100 Holly leaves Dark choc
3,45 x 5,1 cm

003696
140 Holly leaves Dark choc 3 designs



061262
240 Curved leaves White Choc "Bronze et Or"
N/A: USA, China, Japan, Qatar, South Korea

NEW 070432
300 Leaves White Choc "Automne" 4 designs
N/A: USA, China, Singapore



070293
180 Small ribbed leaves Dark choc 4 designs



070361
154 Small maple leaves compound "Automne" 3 designs
3,15 x 3,1 cm • N/A: China, UAE, Saudi Arabia, Qatar, Kuwait, Bahrain, Oman



NEW 088138
108 Leaves White choc, Dark choc and Choc BC "Nervures"
3 designs 4,5 x 2,7 cm - N/A: USA, China, Japan, UAE, Saudi Arabia, Qatar, Kuwait, Bahrain, Oman, South Korea

Free of colouring • Worldwide • Azo



etienne le roy



DECORATIONS



070056
117 Daisies compound
ø 2,5 cm - N/A: China, UAE,
Saudi Arabia, Qatar, Kuwait,
Bahrain, Oman



070504
117 Daisies compound
"Rose" ø 2,5 cm •
N/A: China, Japan, UAE,
Saudi Arabia, Qatar, Kuwait,
Bahrain, Oman, South
Korea



070055
176 Daisies
compound ø 2 cm
N/A: China, UAE, Saudi
Arabia, Qatar, Kuwait,
Bahrain, Oman



070152
176 Daisies
compound "Rose"
ø 2 cm • N/A: China,
Japan, UAE, Saudi
Arabia, Qatar, Kuwait,
Bahrain, Oman, South
Korea



070384
176 Cherry blossom White choc "Sakura" 2 designs • N/A: China,
UAE, Saudi Arabia, Qatar, Kuwait, Bahrain, Oman



070363
176 Cherry blossom compound
"Rose" 3 cm • N/A: China,
UAE, Saudi Arabia, Qatar, Kuwait,
Bahrain, Oman



061313
192 Tiare flowers White
choc 2,5 x 2,5 cm
N/A: USA, China, UAE,
Saudi Arabia, Qatar,
Kuwait, Bahrain, Oman,
Hong Kong



NEW 087134
234 Flowers White Choc "Hippy" 11 designs 2,5 x 2,5 cm
N/A: USA, China, Japan, UAE, Saudi Arabia, Qatar, Kuwait,
Bahrain, Oman, South Korea

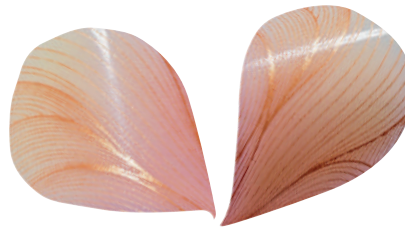

NEW 088119
392 Petals White Choc "Poudré" - N/A: USA, China, Japan,
UAE, Saudi Arabia, Qatar, Kuwait, Bahrain, Oman, South Korea



065215
392 Curved petals White choc "Jaune"
N/A: China, Japan



NEW 088116
117 Daisies White Choc "Acidulé" 3 designs ø 2,5 cm - N/A: USA, China, Japan,
Hong Kong



NEW 088117
176 Daisies compound "Printemps" 3 designs ø 3 cm
N/A: USA, China, Japan, UAE, Saudi Arabia, Qatar, Kuwait, Bahrain,
Oman, Hong Kong

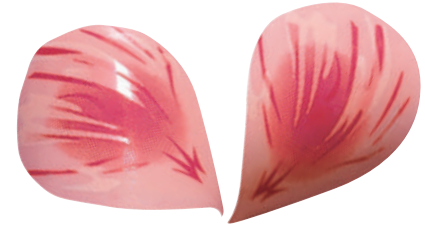

061308
392 Petals White Choc "Rose" - N/A: China, Japan

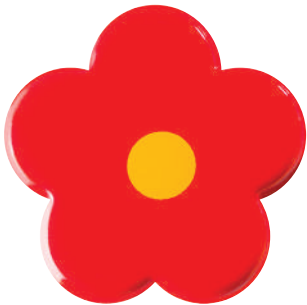

061315
96 Flowers White choc 4 designs ø 4 cm - N/A: China, Japan

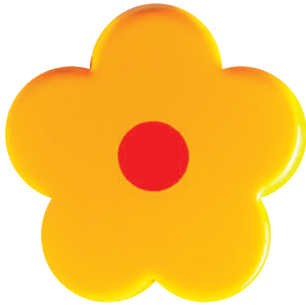

NEW 088232
176 Flowers compound "Frangipanier" 2 designs ø 3 cm - N/A: USA, China,
Japan, UAE, Saudi Arabia, Qatar, Kuwait, Bahrain, Oman



070052
234 Flowers White choc "Multicolores" 10 designs
ø 2,2 cm • N/A: China, UAE, Saudi Arabia, Qatar,
Kuwait, Bahrain, Oman

DECORATIONS



070106

220 Wings for 110 butterflies White choc 10 designs • N/A: UAE, Saudi Arabia, Qatar, Kuwait, Bahrain, Oman



070160

240 Wings for 120 butterflies White choc "Papillon" 12 designs • N/A: UAE, Saudi Arabia, Qatar, Kuwait, Bahrain, Oman

061179

240 Wings for 120 butterflies White choc "Papillon" 12 designs - N/A: China, Japan, Hong Kong



070155

170 Ladybugs White choc 2,1 x 1,9 cm •
N/A: UAE, Saudi Arabia, Qatar, Kuwait, Bahrain, Oman



070050

170 Bees White choc 2,1 x 1,9 cm •
N/A: UAE, Saudi Arabia, Qatar, Kuwait, Bahrain, Oman



NEW 088120

208 Butterflies White Choc "Rainbow" 4 designs 3 x 2,2 cm - N/A: USA, China, Japan, UAE, Saudi Arabia, Qatar, Kuwait, Bahrain, Oman, South Korea

070505 ●●●●●

2 Blisters "Coccinelles" so 340 prints
2,1 x 1,9 cm • N/A: UAE, Saudi Arabia, Qatar,
Kuwait, Bahrain, Oman



FLORENCE LESAGE



EXTRA THIN DECORATIONS



074247

453 Christmas trees extra thin Dark choc, Choc BC and White choc - 9 designs - 2,5 x 3 cm - 3 x 3 cm - 4 x 4 cm

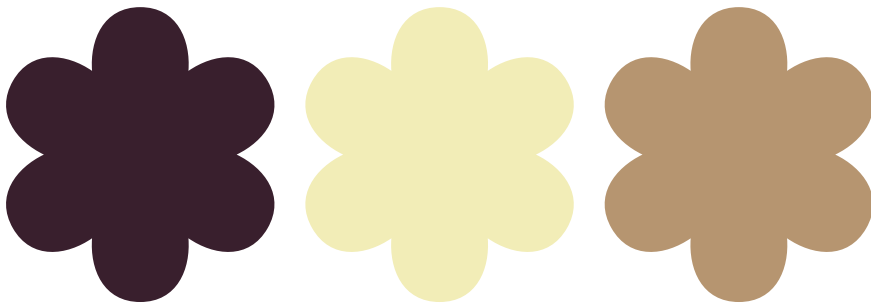

087059

168 Flowers extra thin Dark choc, Choc BC and White choc 3,55 x 3,9 cm



087032

300 Hearts extra thin Dark choc, Choc BC and White choc 4,2 x 4,7 cm

087033



250 Hearts extra thin marbled Dark and White choc several designs 4,2 x 4,7 cm

DECORATIONS





 **060934**
 360 Thin sticks Dark choc 12 x 0,4 cm



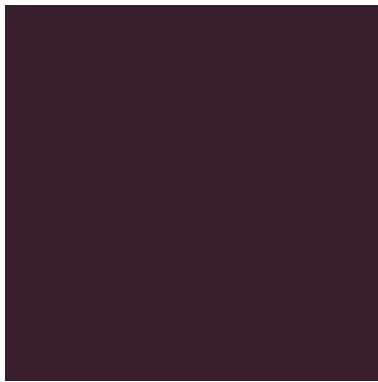

 **NEW 088233**
 315 Squares extra thin Dark choc 4 cm



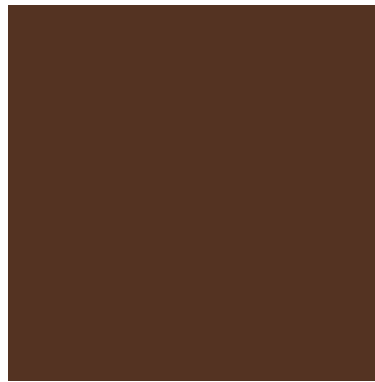

 **030150**
 175 Squares extra thin Dark choc 5 cm



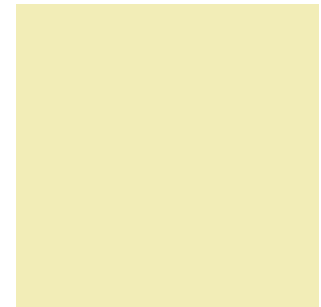

 **030151**
 175 Squares extra thin Milk choc 5 cm





 **NEW 088234**
 315 Squares extra thin White choc 4 cm



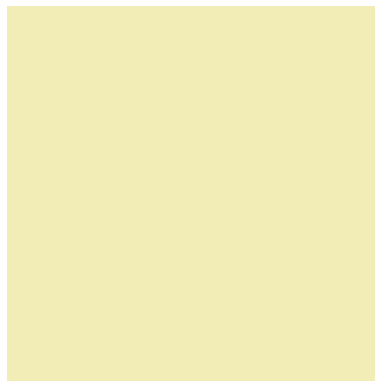

 **030152**
 175 Squares extra thin Choc BC 5 cm

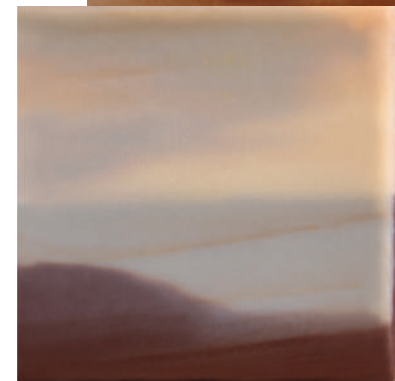

 **030153**
 175 Squares extra thin White choc 5 cm



 **060296**
 175 Squares extra thin marbled Dark and White choc several designs 5 cm

DECORATIONS

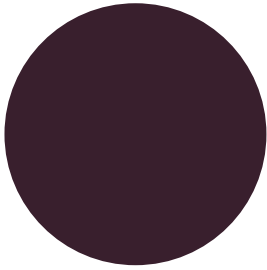

030154
 325 Rounds extra thin Dark choc
 ø 3,5 cm

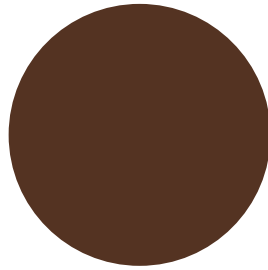

050282
 325 Rounds extra thin Milk choc
 ø 3,5 cm

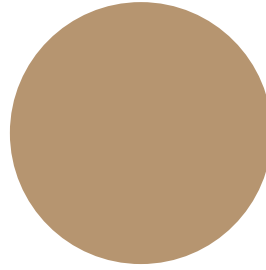

050283
 325 Rounds extra thin Choc BC
 ø 3,5 cm

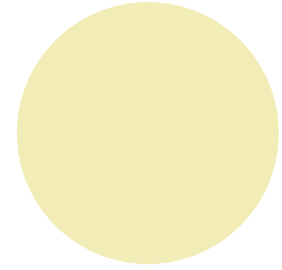

030155
 325 Rounds extra thin White choc
 ø 3,5 cm

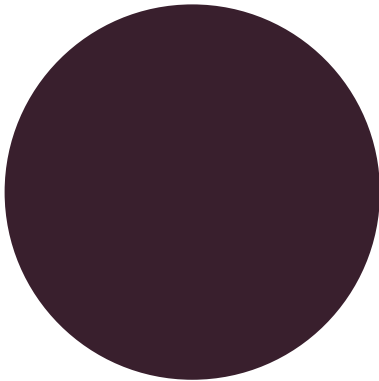

030146
 180 Rounds extra thin Dark choc ø 5 cm

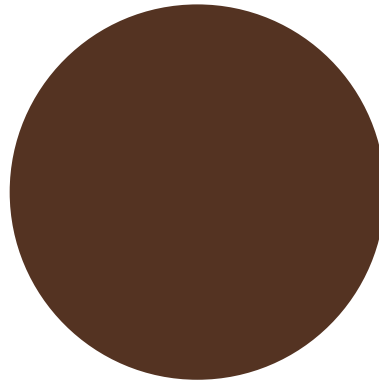

030147
 180 Rounds extra thin Milk choc ø 5 cm

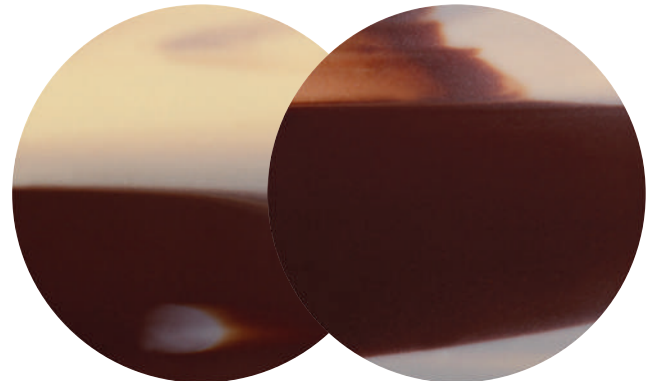

070295
 180 Rounds extra thin marbled Dark and White choc several designs ø 5 cm

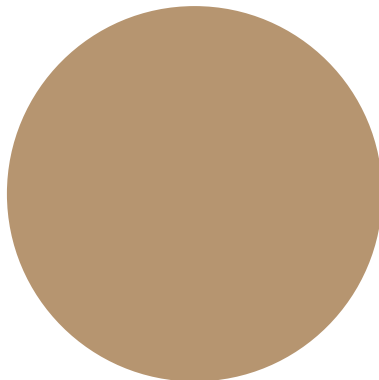

030148
 180 Rounds extra thin Choc BC ø 5 cm

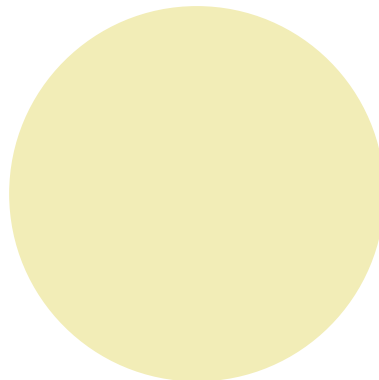

030149
 180 Rounds extra thin White choc ø 5 cm

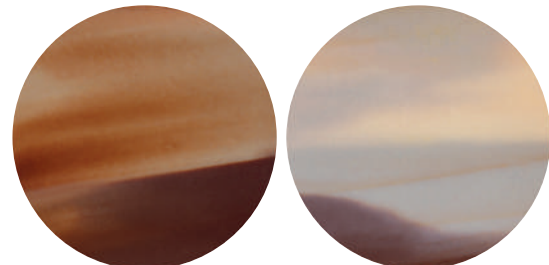

070294
 325 Rounds extra thin marbled Dark and White choc several designs ø 3,5 cm



EMBOSSED EXTRA THIN DECORATIONS

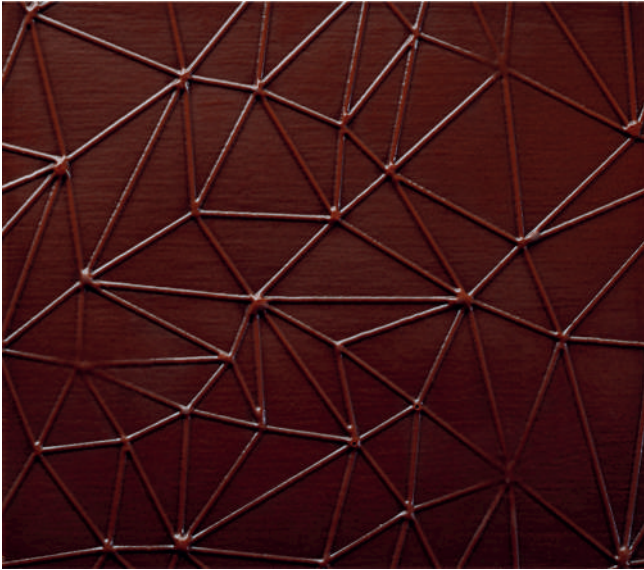

087069
24 Ends of yule log extra thin embossed Dark choc "Polygone" 8,5 x 7,5 cm

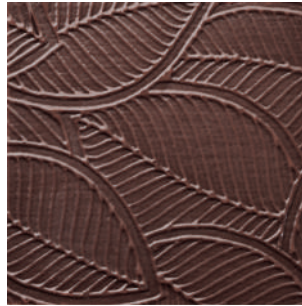

087074
144 Squares extra thin embossed Dark choc "Feuilles" 4 cm



087073
72 Squares extra thin embossed Dark choc "Spirale" 5 cm



087070
66 Rectangles extra thin embossed Dark choc "Feuilles" 12 x 3 cm

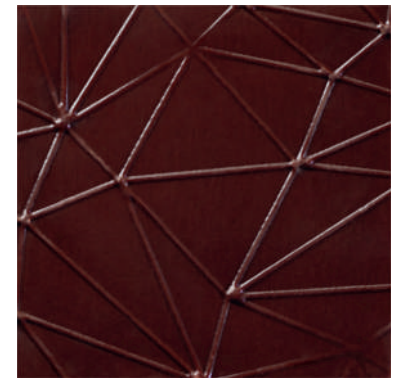

087072
72 Squares extra thin embossed Dark choc "Polygone" 5 cm



087071
66 Rectangles extra thin embossed Dark choc "Spirale" 12 x 3 cm



CURVED DECORATIONS



070107
192 Farandoles White choc
"Mille-feuilles"



061288
192 Farandoles Dark Choc
"Herbes folles"

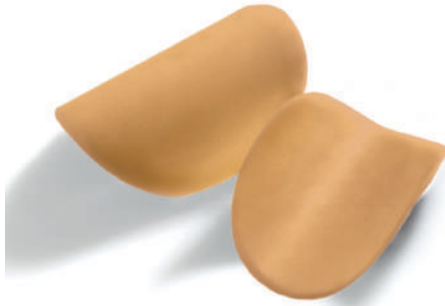

050188
36 Curved rounds Choc BC ø 5 cm



050187
36 Curved rounds Dark choc ø 5 cm



060367
128 Curved petals Dark choc 5 x 2,2 cm



060366
160 Small curved petals Dark choc 4 x 1,7 cm



060375
176 Mini-clasp Dark choc 3,2 x 0,7 cm



060376
176 Mini-clasp White choc 3,2 x 0,7 cm



061060
60 Curved sticks Dark choc
2 designs 17,5 x 1,1 cm
N/A: USA, China, Japan, UAE,
Saudi Arabia, Qatar, Kuwait,
Bahrain, Oman, South Korea



040009
76 Vanilla pods Dark choc
13,5 x 1,2 cm



004837
80 Branches
Dark choc
13,5 x 1,3 cm



061264
96 Sticks White
choc "Bambou"
12,8 x 1 cm
N/A: China



061265
144 Sticks White Choc "Sucre d'orge" 9 designs
13,75 x 0,6 cm - N/A: China, Japan, UAE, Saudi
Arabia, Qatar, Kuwait, Bahrain, Oman, Hong Kong

DECORATIONS



061266
144 Sticks White choc
8 designs 13,75 x 0,6 cm
N/A: USA, China, Japan, Qatar, South Korea



061267
144 Sticks Dark choc
8 designs 13,75 x 0,6 cm
N/A: USA, China, Japan, Qatar, South Korea



070147
144 Sticks White choc
"Mini brisures"
13,75 x 0,6 cm
N/A: China, Taiwan



 **087053**
144 Sticks White choc
"Lignes"
13,75 x 0,6 cm



061268
144 Sticks Dark choc
"Lignes"
13,75 x 0,6 cm
N/A: USA, China, South Korea, Japan, UAE, Saudi Arabia, Kuwait, Oman, Bahrain, Qatar

 Free of colouring  Worldwide • Azo

DECORATIONS



004799
90 Mini spoons Dark choc "Arabesques" 8 x 2 cm • N/A: China, UAE, Saudi Arabia, Qatar, Kuwait, Bahrain, Oman



 **070042**
90 Mini spoons White choc "Arabesques" 8 x 2 cm



 **070364**
192 Peanuts Choc BC 4 x 1,75 cm



 **004746**
132 Mini tablettes Dark choc 4 x 3 cm

 **001456**
2 Blisters Mini tablettes so 132 prints 4 x 3 cm



061398
280 Squares White Choc "Moucheté rouge" 3 cm - N/A: USA, China, Japan



 **070096**
280 Squares White Choc "Moucheté caramel" 3 cm
N/A: China, Taiwan

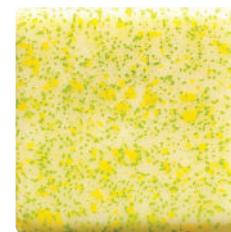

061284
280 Squares White Choc "Moucheté vert" 3 cm
N/A: China



087038
110 Drops Dark choc "Inde" 4,4 x 2,9 cm - 2 designs - N/A: China, Japan, Hong Kong



061286
230 Triangles Dark Choc "Arabesques" 3,3 x 5,5 cm
N/A: China



003285
567 Rounds Dark choc "Tendance" 8 designs ø 3 cm
N/A: USA, China, Japan, Qatar, South Korea



065310
Coffee Beans Dark choc Shiny bronze 1,5 x 1,3 cm - 200 g
N/A: USA, China, Japan, Qatar, South Korea



 **010399**
Coffee Beans Dark choc - 285 g
N/A: China, Japan





MIXED CIRCLES

Please note the decorations are not shown in real size.



070108

144 Mixed circles White choc "Moucheté caramel" 3 sizes
N/A: China, Taiwan



070149

144 Mixed circles White choc "Sucre d'orge" 3 sizes • N/A: UAE, Saudi Arabia, Qatar, Kuwait, Bahrain, Oman



070223

144 Mixed circles White choc "Ronce de noyer" 3 sizes •
N/A: UAE, Saudi Arabia, Qatar, Kuwait, Bahrain, Oman



061292

144 Mixed circles White choc "Rayures roses" 3 sizes
N/A: China, Japan



061296

144 Mixed circles Dark choc "Cuivrés" 3 sizes
N/A: USA, China, Japan, Qatar, South Korea

EMBOSSED PIECES



060942
176 Rounds Dark choc embossed "Cabosse" ø 2,5 cm



060943
176 Rounds Milk choc embossed "Café" ø 2,5 cm

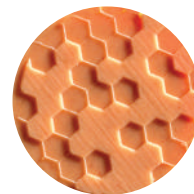

060944
176 Rounds Choc BC embossed "Miel" ø 2,5 cm



074268
72 Butterflies wings Dark choc embossed 2 designs 3,2 x 4,5 cm



JOYEUX ANNIVERSAIRE

050280
45 Rectangles Dark choc embossed "Joyeux anniversaire" 7 x 1,5 cm



NEW 087101
100 Hearts White choc embossed "Je t'aime" 5,85 x 5,4 cm

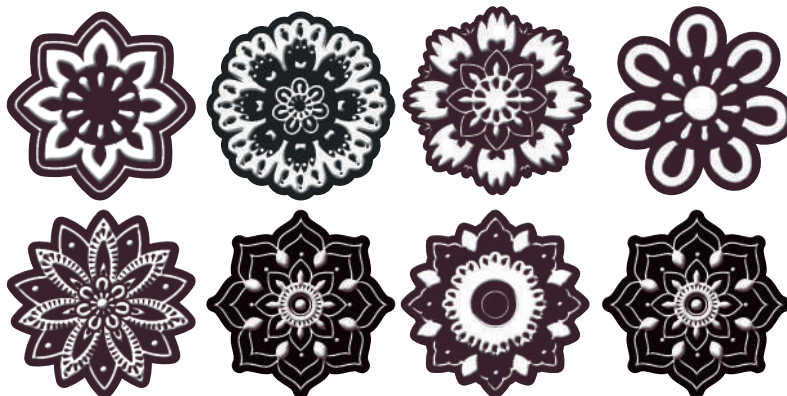

045733
528 Flowers Dark choc embossed white 8 designs ø 2,5 cm



HAPPY
Birthday

HAPPY BIRTHDAY DECORATIONS



070506
36 Ovals Dark choc "Happy Birthday" 6,2 x 3,7 cm - N/A: UAE, Saudi Arabia, Qatar, Kuwait, Bahrain, Oman

087063
72 Ovals Dark choc "Happy Birthday" 6,2 x 3,7 cm - N/A: China, Japan, Hong Kong



061378
152 Candles White choc 6 designs 0,8 x 6,6 cm - N/A: China, UAE, Saudi Arabia, Qatar, Kuwait, Bahrain, Oman, Hong Kong



061012
40 Rectangles White choc "Joyeux anniversaire" 7 x 5 cm
N/A: USA, China, Japan, Hong Kong



070260
75 Rectangles Dark choc "Happy birthday" 6 x 3,5 cm
N/A: UAE, Saudi Arabia, Qatar, Kuwait, Bahrain, Oman



003173
150 Rectangles Milk choc "Congratulations" 6 x 3 cm - N/A: UAE, Saudi Arabia, Qatar, Kuwait, Bahrain, Oman



All of our chocolate pieces can be personalized in your language. Contact-us!



061375
33 Banners Dark choc "Joyeux Anniversaire" 7,87 x 3,32 cm

061376
165 Banners Dark choc "Joyeux Anniversaire" 7,87 x 3,32 cm



070507
70 Rectangles Dark choc "Happy Anniversary" 7 x 1,5 cm
N/A: UAE, Saudi Arabia, Qatar, Kuwait, Bahrain, Oman



061377
70 Rectangles Dark choc "Joyeux Anniversaire" 7 x 1,5 cm
N/A: China



MARSHMALLOW DECORATIONS

Marshmallow: reminiscent of childhood sweetness and ideal for sumptuous decorations...
These decorations come in a range of special Bar decorations, composed of "Latte Art" discs to be deposited on the foam of your espresso and hot chocolate



070296

288 Marshmallow rounds "Latte art" 9 designs ø 3 cm - N/A: UAE, Saudi Arabia, Qatar, Kuwait, Bahrain, Oman



087007

120 Marshmallow rounds "Café latte" 6 designs ø 4 cm - N/A: USA, China, Japan, UAE, Saudi Arabia, Qatar, Kuwait, Bahrain, Oman, South Korea





DECORATIONS TO SPRINKLE

Discover edible dried flowers, lovingly selected by hand. You will be delighted by their beautiful natural colours and shapes. Liven up your dishes and cakes, whether it be desserts, macaroons, cupcakes, ice cream, chocolate truffles, whipped cream... These flowers are 100% natural, so please note that their colours may change depending on the season. *These products are the fruit of nature and are handpicked, which may limit the quantities available.*

DRIED FLOWERS



050293
50 Edible dried four-leaf clovers
N/A: USA, UAE, Saudi Arabia, Qatar, Kuwait, Bahrain, Oman



050294
50 Edible dried red vervain flowers
N/A: USA, UAE, Saudi Arabia, Qatar, Kuwait, Bahrain, Oman



050295
50 Edible dried blue vervain flowers
N/A: USA, UAE, Saudi Arabia, Qatar, Kuwait, Bahrain, Oman



050296
50 Edible dried white vervain flowers
N/A: USA, UAE, Saudi Arabia, Qatar, Kuwait, Bahrain, Oman



050297
50 Edible dried pink vervain flowers
N/A: USA, AE, Saudi Arabia, Qatar, Kuwait, Bahrain, Oman



NEW 088211
Dried blue cornflower flowers 8 g - N/A: USA, UAE



NEW 088212
Dried pink cornflower flowers 8 g - N/A: USA, UAE



NEW 088213
Dried yellow marigold flowers 12 g
N/A: USA, UAE

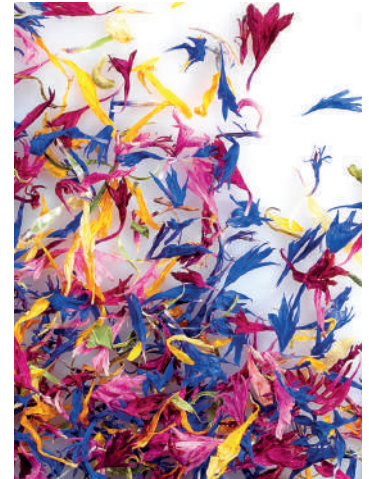

NEW 088214
Mix of dried flowers 12 g - N/A: USA, UAE



DECORATIONS TO SPRINKLE

Discover our new range of edible freeze-dried flowers, lovingly selected by hand. You will be delighted by their beautiful natural colours and shapes. Liven up your dishes and cakes, whether it be desserts, macaroons, cupcakes, ice cream, chocolate truffles, whipped cream... These flowers are 100% natural, so please note that their colours may change depending on the season.



NEW 088205
Freeze-dried lilac flowers 2 g - N/A: USA, UAE



NEW 088206
Freeze-dried elderflowers 5 g - N/A: USA, UAE



NEW 088207
Mini freeze-dried rose petals "Rose pâle" 2 g - N/A: USA, UAE



NEW 088208
Small freeze-dried rose petals "Violet" 2 g - N/A: USA, UAE



NEW 088209
Small freeze-dried rose petals "Rose vif" 2 g - N/A: USA, UAE



NEW 088210
Large freeze-dried rose petals "Rose pâle" 2 g - N/A: USA, UAE



DECORATIONS TO SPRINKLE

FRUIT PIECES



050225
Whole raspberries - 60 g



045005
Strawberry pieces - 80 g
N/A: Taiwan



045006
Raspberry pieces - 80 g

CRISPY



060951
Coco Crispy - 150 g - N/A: USA



060949
Strawberry Crispy - 200 g
N/A: USA, Taiwan



060950
Raspberry Crispy - 200 g - N/A: USA



070589
Lime crispy - 180 g - N/A: USA

CRISPY WETPROOF



NEW 088141
Strawberry Crispy wetproof 400 g
N/A: Taiwan



NEW 088142
Raspberry Crispy wetproof 400 g



NEW 088143
Lime Crispy wetproof 350 g

Ideal for bringing **texture** with a pure taste of fruit, **moisture resistant**, they can be used in decoration or even in inclusion, topping...

NEW!

JOYEUSES
Fêtes

DECORATIONS TO SPRINKLE

MERINGUETTES
& MINI MERINGUES

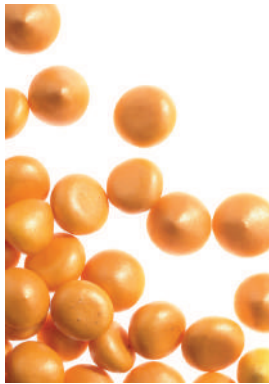

065292
Meringuettes coated gold - 350 g
N/A: USA, China, Japan, Qatar, South Korea

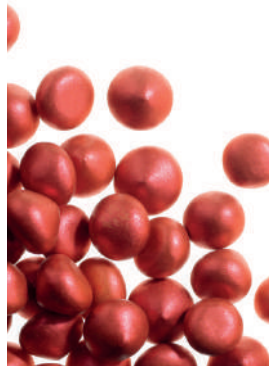

065293
Meringuettes coated red - 350 g
N/A: USA, China, Japan, South Korea



 **060953**
Meringuettes coated white choc
350 g - N/A: China, Japan



 **060952**
 Meringuettes egg-free - 250 g

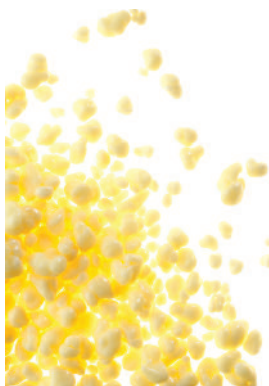

 **060343**
Mini meringues coated white choc
210 g - N/A: China, Japan



 **060345**
Mini meringues coated dark choc
210 g - N/A: China, Japan



 **060344**
Mini meringues coated milk choc
210 g - N/A: China, Japan



 **060346**
Mini meringues coated white, dark
and milk choc - 210 g
N/A: China, Japan



HAZELNUTS & ALMONDS



060963
Golden chips (hazelnuts & almonds)
200 g - N/A: USA, China, Japan, Qatar,
South Korea

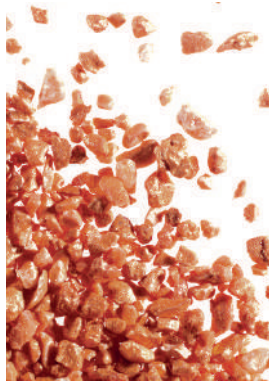

010437
Bronze chips (hazelnuts & almonds)
200 g - N/A: USA, China, Japan, Qatar,
South Korea



OTHER PACKAGING
OPTIONS ARE
AVAILABLE
UPON REQUEST
Contact-us!

CARAMEL CHIPS

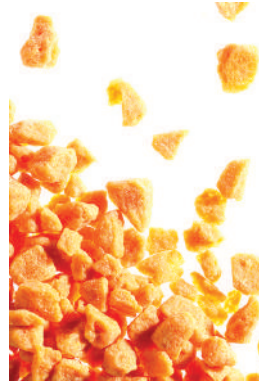

060954
Caramel chips - 350 g



004628
Isigny caramel chips - 250 g

CRISPY SPANGLES



010420
Golden crispy spangles - 500 g
N/A: USA, Canada, China, Japan, UAE,
Saudi Arabia, Qatar, Kuwait, Bahrain,
Oman, South Korea



060565
Bronze crispy spangles - 500 g
N/A: USA, Canada, China, Japan, Qatar,
South Korea

CHIPS



070267
Chocolate chips - 500 g



060948
Cocoa nibs - 350 g

“Kipetti” crackles and pops in your mouth. Add them to your chocolates, your cups or just about anything... Kipetti enrobed in chocolate: Chocolate protects the Kipetti from moisture thus making it possible to incorporate them into moist mixtures.

KIPETTIS

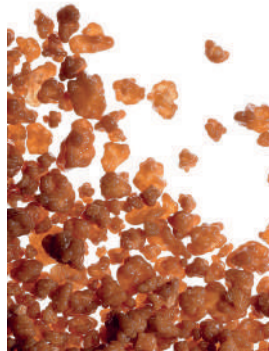

004557
Kipetti coated - 1 kg
N/A: USA



004631
Kipetti coated bronze - 250 g
N/A: USA, China, Japan, Qatar, South
Korea



004632
Kipetti coated gold - 250 g
N/A: USA, China, Japan, UAE, Saudi
Arabia, Qatar, Kuwait, Bahrain, Oman,
South Korea



004638
Kipetti nature - 1 kg
N/A: USA



Mini balls average size: $\varnothing \pm 0,3$ cm
 Crunchies average size: $\varnothing \pm 0,5$ cm

DECORATIONS TO SPRINKLE

MINI BALLS



010427
 Mini balls silver - 220 g
 N/A: USA, Canada, China, Japan, UAE,
 Saudi Arabia, Qatar, Kuwait, Bahrain,
 Oman, South Korea

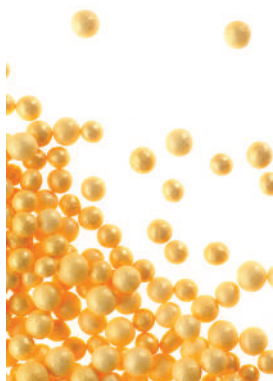

010431
 Mini balls gold - 220 g
 N/A: USA, Canada, China, Japan, UAE,
 Saudi Arabia, Qatar, Kuwait, Bahrain,
 Oman, South Korea

CRUNCHIES

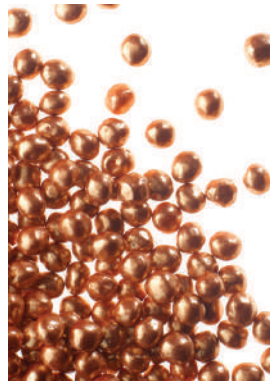

010397
 Crunchies bronze - 170 g
 N/A: USA, Canada, China, Japan, Qatar,
 South Korea



010426
 Crunchies purple - 170 g
 N/A: Canada, China, Japan, UAE, Saudi
 Arabia, Qatar, Kuwait, Bahrain, Oman,
 South Korea

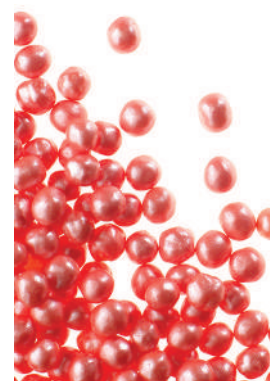

010411
 Crunchies pink - 170 g •
 N/A: Canada, China, Japan, UAE, Saudi
 Arabia, Qatar, Kuwait, Bahrain, Oman,
 South Korea

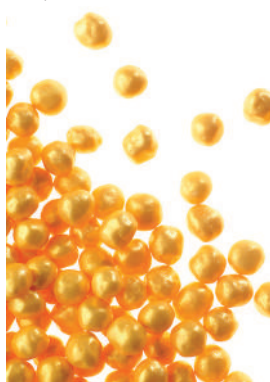

010410
 Crunchies gold - 170 g
 N/A: USA, Canada, China, Japan, UAE,
 Saudi Arabia, Qatar, Kuwait, Bahrain,
 Oman, South Korea



010412
 Crunchies silver - 170 g
 N/A: Canada, China, Japan, UAE, Saudi
 Arabia, Qatar, Kuwait, Bahrain, Oman,
 South Korea



045656
 Crunchies ruby - 170 g
 N/A: USA, Canada, China, Japan, South
 Korea



 **010440**
 Crunchies dark - 500 g
 N/A: Canada, China, Japan

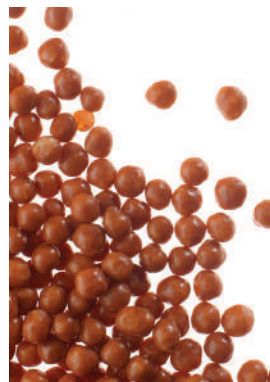

 **010379**
 Crunchies milk - 500 g
 N/A: Canada, China, Japan



 **010380**
 Assorted crunchies black, milk and
 white - 500 g - N/A: Canada, China,
 Japan

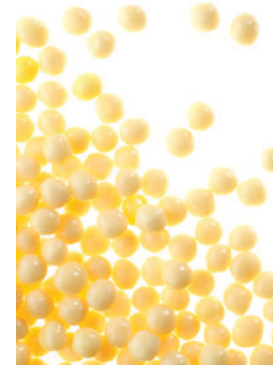

 **010441**
 Crunchies white - 500 g
 N/A: Canada, China, Japan



 **060554**
 White hail (hazelnuts coated)
 250 g



060555
 Maxi hazelnuts silver - 250 g
 N/A: USA, China, Japan, UAE, Saudi
 Arabia, Qatar, Kuwait, Bahrain, Oman,
 South Korea, Taiwan



010414
 Silver balls - 250 g - N/A: USA, China,
 Japan, UAE, Saudi Arabia, Qatar, Kuwait,
 Bahrain, Oman, South Korea, Taiwan

 **010388**
 Assorted crunchies black, milk and
 white - 2,5 kg - N/A: Canada, China,
 Japan

 Free of colouring  Worldwide • Azo

FLOWER CHIPS



008695

Violet chips - 250 g - N/A: USA, China, Japan, South Korea



008693

Rose chips - 250 g - N/A: USA, China, Japan

HEARTS

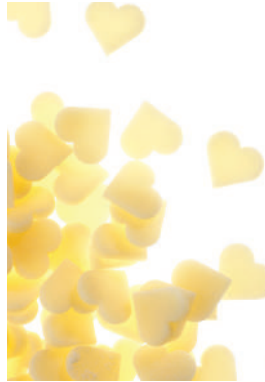

045675

White choc hearts 0,9 cm - 200 g



074335

Sugar hearts shiny ruby 0,6 cm 200 g
N/A: USA, Canada, China, Japan, South Korea, Taiwan

CONFETTIS



074336

Sugar mini-confetti shiny bronze
ø 0,4 cm - 200 g - N/A: USA, Canada, China, Japan, Qatar, South Korea, Taiwan

STARS



045668

Chocolate stars shiny silver 0,9 cm
200 g - N/A: USA, China, Japan, UAE, Saudi Arabia, Qatar, Kuwait, Bahrain, Oman, South Korea



045669

Chocolate stars shiny bronze
0,9 cm - 200 g - N/A: USA, China, Japan, Qatar, South Korea



045667

Chocolate stars shiny gold
0,9 cm - 200 g - N/A: USA, China, Japan, UAE, Saudi Arabia, Qatar, Kuwait, Bahrain, Oman, South Korea



045671

White choc stars 0,9 cm - 200 g



045670

Dark choc stars 0,9 cm - 200 g



045664

Mini white stars 3 mm - 200 g



(088029 - Christmas balls
"Graphique" + 070540 - Yule log
moulds (top) "Éminence" + 070538
Yule log moulds (bottom) "Dessous
de bûches")



SILVER & GOLD



036141
Plier for gold



025235
Sprinkler

In flakes, sheets or petals...
For the utmost in sophistication, sprinkle these precious touches of real gold and silver on your desserts, entremets or chocolates. Discover how our real gold threads can give an incomparable gleam to all your creations.



025227
25 Genuine gold leaves in book loose
8 x 8 cm - N/A: USA, Canada, China, Japan



025231
Genuine gold petals - 500 mg per box
N/A: USA, Canada, China, Japan



025233
Genuine gold chips - 1 g per box
N/A: USA, Canada, China, Japan



087085
Genuine gold powder - 1 g per box
N/A: USA, Canada, China, Japan



025228
25 Genuine silver leaves in book loose
8 x 8 cm - N/A: USA, China, Japan, South Korea, Taiwan



025232
Genuine silver petals - 500 mg per box - N/A: USA, China, Japan, South Korea, Taiwan



025234
Genuine silver chips - 1 g per box
N/A: USA, China, Japan, South Korea, Taiwan



087086
Genuine gold powder - 1 g per box
N/A: USA, China, Japan, South Korea, Taiwan



004574
1 Spray gold spangles
200 ml - N/A: USA, Canada, China, Japan, UAE, Saudi Arabia, Qatar, Kuwait, Bahrain, Oman

STENCILS & SILICONE MOULDS FOR
CHOCOLATE DECORATIONS



DO IT YOURSELF



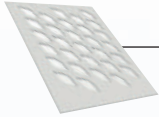

🌿 **010738**
1 Stencil for leaves
30 prints 7 x 3 cm



🌿 **010690**
1 Stencil for rectangles
15 prints 7 x 1,5 cm



🌿 **010691**
1 Stencil for rectangles
20 prints 7 x 2 cm



🌿 **010704**
1 Stencil for squares
24 prints 2 cm

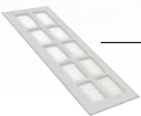

🌿 **010692**
1 Stencil for rectangles
10 prints 6 x 4 cm

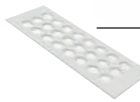

🌿 **040021**
1 Stencil for rounds
24 prints ø 3 cm

MARC
Rivière



🌿 **010706**
1 Stencil for rounds ø 2 cm, ø 2,7 cm and ø 3,4 cm 117 prints

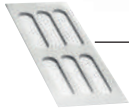

010700
1 Stencil for eclairs
6 prints 13,2 x 3,2 cm

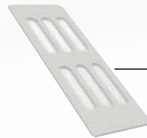

030068
1 Stencil for thin eclairs
6 prints 12 x 2,6 cm



019153
1 Stencil for rabbits 4 prints
5,3 x 13,5 cm Th. 0,3 mm



010166
1 Silicone mould "4 mains avec bras courts"

CHRISTOPHE
Michalak



009908
1 Silicone mould "Les cordelettes"
3 designs 50 cm

FRANÇOIS
Galtier



010225
4 Silicone moulds "Montre" 4 designs
Dial: ø 16 cm - Great gear: ø 14 cm
Necklace: ø 16 cm
Winder: ø 4,5 cm

010226
1 Silicone mould "Engrenages"
9 designs - 9 Gears between
ø 2 and ø 4 cm



TRANSFER SHEETS



SEE INSTRUCTIONS ON OUR WEBSITE



NEW 088008 "Paisley" ●●●●●
17 Transfer sheets 40 x 25 cm - N/A: USA, China, Japan, Qatar, South Korea, Hong Kong



060144 "Robusta scintillant" ●●●●●
17 Transfer sheets 40 x 25 cm - N/A: USA, China, Japan, UAE, Saudi Arabia, Qatar, Kuwait, Bahrain, Oman, South Korea



007592 "Opulence" ●●●●●
17 Transfer sheets 40 x 25 cm - N/A: USA, China, Japan, UAE, Saudi Arabia, Qatar, Kuwait, Bahrain, Oman, South Korea



007615 "Cuivre et argent" ●●●●●
17 Transfer sheets 40 x 25 cm - N/A: USA, China, Japan, UAE, Saudi Arabia, Qatar, Kuwait, Bahrain, Oman, South Korea



087000 "Rondin" ●●●●●
17 Transfer sheets 40 x 25 cm - N/A: USA, China, Japan, UAE, Saudi Arabia, Qatar, Kuwait, Bahrain, Oman, South Korea



087039 "Romance Indienne" ●●●●●
17 Transfer sheets 40 x 25 cm - N/A: China, Japan, Hong Kong

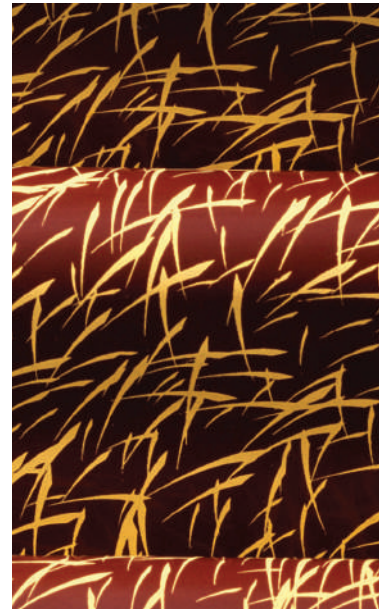

070204 "Mikado Or" ●●●●●
17 Transfer sheets 40 x 25 cm - N/A: UAE, Saudi Arabia, Qatar, Kuwait, Bahrain, Oman

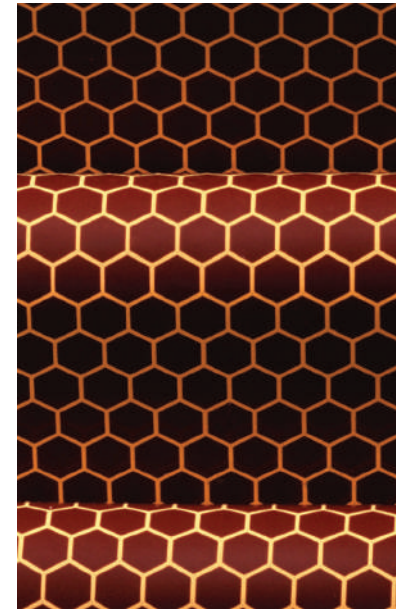

070201 "Alvéoles" ●●●●●
17 Transfer sheets 40 x 25 cm • N/A: UAE, Saudi Arabia, Qatar, Kuwait, Bahrain, Oman

Free of colouring Worldwide • Azo ●●●●● Usable chocolates

TRANSFER SHEETS



065019 "Canopée" ● ● ● ● ●
17 Transfer sheets 40 x 25 cm
N/A: China, Singapore



🌿 **045509 "Veinage"** ● ● ● ● ●
17 Transfer sheets 40 x 25 cm



087002 "Cacao" ● ● ● ● ●
17 Transfer sheets 40 x 25 cm
N/A: China, Singapore



🌿 **NEW 088004 "Agrumes"** ● ● ● ● ●
17 Transfer sheets 40 x 25 cm



036144 "Paris Rubis" ● ● ● ● ●
17 Transfer sheets 40 x 25 cm - N/A: USA, China,
Japan, UAE, Saudi Arabia, Qatar, Kuwait, Bahrain,
Oman, South Korea



061335 "Tout feu tout flamme" ● ● ● ● ●
17 Transfer sheets 40 x 25 cm • N/A: UAE, Saudi Arabia,
Qatar, Kuwait, Bahrain, Oman

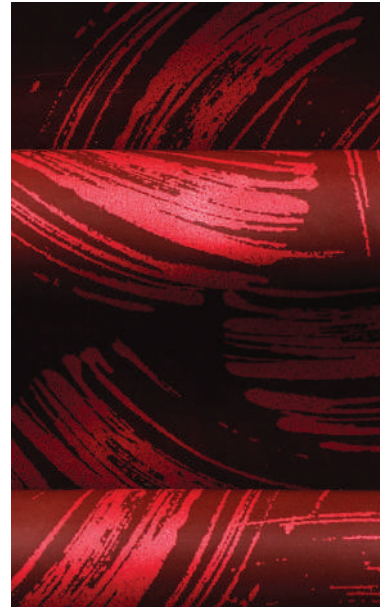

036142 "Londres rubis" ● ● ● ● ●
17 Transfer sheets 40 x 25 cm - N/A: USA, China,
Japan, UAE, Saudi Arabia, Qatar, Kuwait, Bahrain,
Oman, South Korea



061186 "Les cuivrés" ● ● ● ● ●
17 Transfer sheets 40 x 25 cm - N/A: USA, China,
Japan, UAE, Saudi Arabia, Qatar, Kuwait, Bahrain,
Oman, South Korea





TRANSFER SHEETS



NEW 088015 "Bouquet Floral" ●●●●
17 Transfer sheets 40 x 25 cm
N/A: China, Japan, Hong Kong



NEW 088003 "Citronnier" ●●●●
17 Transfer sheets 40 x 25 cm - N/A: Hong Kong



070218 "Un peu, beaucoup" ●●●●●
17 Transfer sheets 40 x 25 cm • N/A: UAE, Saudi Arabia,
Qatar, Kuwait, Bahrain, Oman

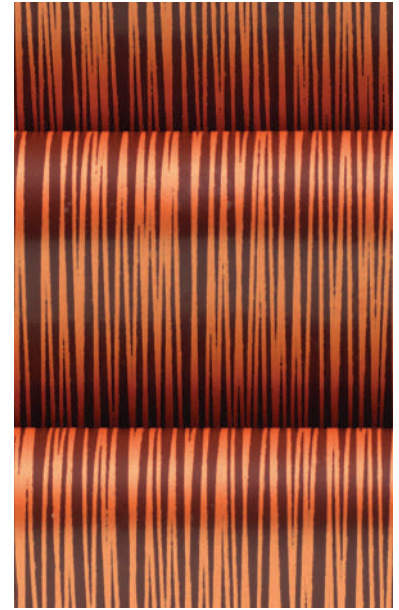

060151 "Pur éclat bronze" ●●●●●
17 Transfer sheets 40 x 25 cm - N/A: USA, China,
Japan, UAE, Saudi Arabia, Qatar, Kuwait, Bahrain,
Oman, South Korea



070207 "Rayures" ●●●●●
17 Transfer sheets 40 x 25 cm • N/A: USA, China, Japan,
UAE, Saudi Arabia, Qatar, Kuwait, Bahrain,
Oman, South Korea, Singapore



NEW 088014 "Hippy" ●●●●
17 Transfer sheets 40 x 25 cm - N/A: China, Japan

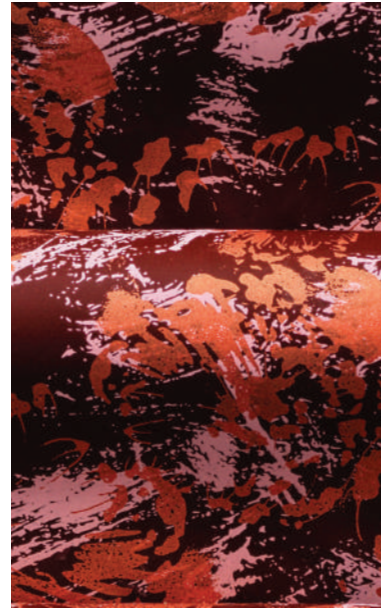

070199 "Coup de pinceau" ●●●●●
17 Transfer sheets 40 x 25 cm • N/A: USA, China,
Japan, UAE, Saudi Arabia, Qatar, Kuwait, Bahrain,
Oman, South Korea



070211 "Papier reliure" ●●●●●
17 Transfer sheets 40 x 25 cm • N/A: UAE, Saudi Arabia,
Qatar, Kuwait, Bahrain, Oman

TRANSFER SHEETS

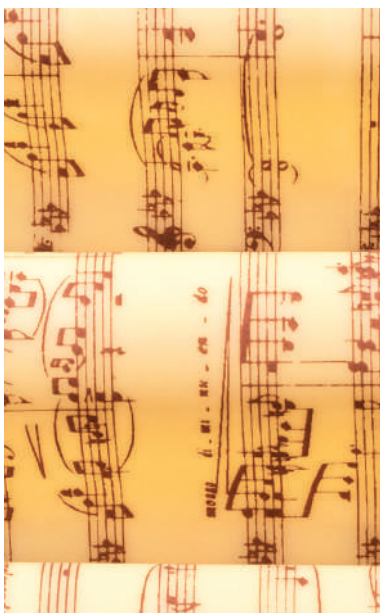

070200 "Notes de musique" ●●●●●
17 Transfer sheets 40 x 25 cm



070003 ●●●●●
17 Transfer sheets "Moucharabieh" 40 x 25 cm
N/A: UAE, Saudi Arabia, Qatar, Kuwait, Bahrain, Oman

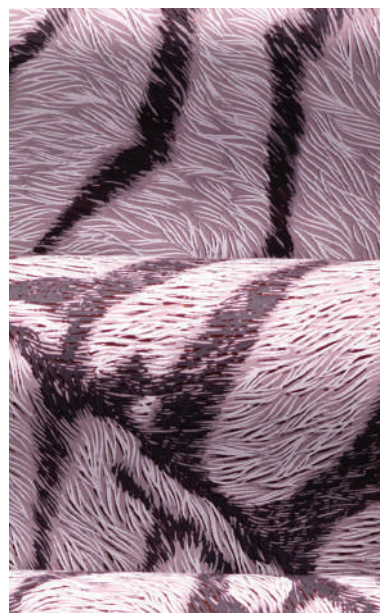

070209 "Zèbre" ●●●●●
17 Transfer sheets 40 x 25 cm - N/A: UAE, Saudi Arabia,
Qatar, Kuwait, Bahrain, Oman



065224 "Kaleidoscope" ●●●●●
17 Transfer sheets 40 x 25 cm - N/A: China, Singapore,



070206 "Herbe" ●●●●●
17 Transfer sheets 40 x 25 cm - N/A: UAE, Saudi Arabia,
Qatar, Kuwait, Bahrain, Oman



061330 "Le peigne d'Eddy" ●●●●●
17 Transfer sheets 40 x 25 cm - N/A: China, UAE, Saudi
Arabia, Qatar, Kuwait, Bahrain, Oman



NEW 088001 "Rameaux" ●●●●●
17 Transfer sheets 40 x 25 cm - N/A: USA, China,
Japan, UAE, Saudi Arabia, Qatar, Kuwait, Bahrain,
Oman, South Korea, Hong Kong



NEW 088018 "Wagara" ●●●●●
17 Transfer sheets 40 x 25 cm - N/A: USA, China,
Japan, UAE, Saudi Arabia, Qatar, Kuwait, Bahrain,
Oman, South Korea, Hong Kong





SUGGESTIONS

Make your Bonbons pop
with some Kipettis p. 185



TRANSFER CUTOUTS 4 X 4 CM

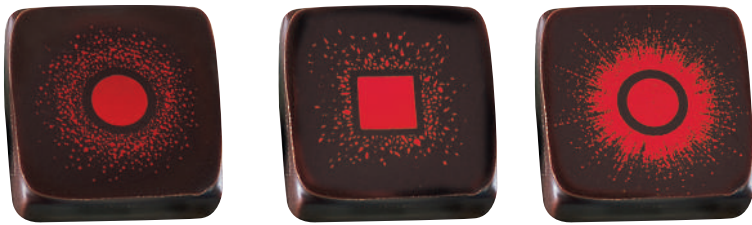

060878 ●●●●

1500 Transfer sheets "Cœur de Grenat" 3 Designs 4 x 4 cm - N/A: China, Japan



These individual transfer sheets centered on your chocolate bonbons will awaken your customers' tastebuds to the subtle flavours of the fillings and give your products a truly individual signature. These designs are available in 36 x 13 cm sheets or in 4 x 4 cm cutouts (remember to specify your preferred format in your order). A wide variety of additional patterns and flavours are available upon request.

SEE INSTRUCTIONS ON OUR WEBSITE



060876 ●●●●

1500 Transfer sheets "Cœur d'ambre" 3 Designs 4 x 4 cm

060877 ●●●●

1500 Transfer sheets "Cœur de Jade" 3 Designs 4 x 4 cm

070420 ●●●●

1500 Transfer sheets "Feuille gravure" 6 designs 4 x 4 cm - N/A: USA, China, Japan, UAE, Saudi Arabia, Qatar, Kuwait, Bahrain, Oman, South Korea



060875 ●●●●●

1500 Transfer sheets "Pollock" 4 x 4 cm - N/A: China, Singapore

060122 ●●●●●

1500 Transfer sheets "Fils scintillants" 2 designs 4 x 4 cm - N/A: USA, China, Japan, UAE, Saudi Arabia, Qatar, Kuwait, Bahrain, Oman, South Korea

074192 ●●●●●

1500 Transfer sheets "Estampe Rubis" 6 designs 4 x 4 cm N/A: USA, China, Japan, UAE, Saudi Arabia, Qatar, Kuwait, Bahrain, Oman, South Korea

074193 ●●●●●

1500 Transfer sheets "Estampe Bronze" 6 designs 4 x 4 cm N/A: USA, China, Japan, UAE, Saudi Arabia, Qatar, Kuwait, Bahrain, Oman, South Korea



061195 ●●●●●

1500 Transfer sheets "Éclat or" 4 x 4 cm - N/A: USA, China, Japan, UAE, Saudi Arabia, Qatar, Kuwait, Bahrain, Oman, South Korea

061194 ●●●●●

1500 Transfer sheets "Touche prestige or" 4 x 4 cm - N/A: USA, China, Japan, UAE, Saudi Arabia, Qatar, Kuwait, Bahrain, Oman, South Korea

061193 ●●●●●

1500 Transfer sheets "Artiste" 4 designs, 4 x 4 cm - N/A: China, Japan

045797 ●●●●●

3000 Transfer sheets "Thé" 4 x 4 cm

045798 ●●●●●

3000 Transfer sheets "Caramel" 4 x 4 cm

045799 ●●●●●

3000 Transfer sheets "Café" 4 x 4 cm



STRUCTURE SHEETS FOR BONBON

Add eye-catching relief to your chocolates with our texture sheets...

Give traditional products more punch with these original, easy-to-use designs. After enrobing chocolate bonbons, just place the sheet on top, wait until the chocolate has set and remove.

STRUCTURE SHEETS - 27 Sheets 40 x 25 cm



040169
"Madras"



060131
"Bulles"



011197
"Tressé"



011170
"Faux bois"



NEW 088021
"Grain de café"



NEW 088022
"Cabosse"



011185
"Facettes"



011178
"Mailles"



045516
"Plumetis"



011180
"Averse"



011167
"Matelassé"



050062
"Fleurettes"

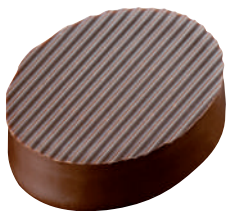

011193
"Lignes"



011164
"Petites arabesques"



011181
"Fibres"



011166
"Cabosses"



060873
"Craquelures"



065296
"Feuilles"



011175
"Damier"



011182
"Filaments"



011172
"Floral"



074288
"Étoiles"



060874
"Envol"



060132
"Strates"

Free of colouring • Worldwide • Azo • Usable chocolates



KITS

MARSHMALLOW MOULDS

Gourmets will be delighted with our new range of adorable marshmallow moulds!
All our moulds are suitable for manual or one-shot use, thanks to a center distance of 70 mm.



SEE INSTRUCTIONS ONLINE



NEW 088242

10 Marshmallow moulds "Fantôme" for 120 pieces
5,7 x 7 cm - Th. 2 cm



NEW 088243

10 Marshmallow moulds "Ourson" for 80 pieces
5 x 8 cm - Th. 2,2 cm



NEW 088244

10 Marshmallow moulds "Lapinou" for 80 pieces
4,3 x 8,5 cm - Th. 2,4 cm



Free of colouring • Worldwide • Azo



KITS

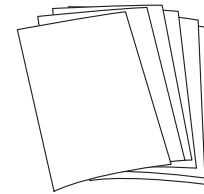

BLISTERS FOR LOLLIPOPS

061248 ●●●●●

9 Blisters lollipops "Nounours" and sticks for 45 prints 5 designs ø 5,5 cm - Weight: ± 15 g
N/A: China, Japan, UAE, Saudi Arabia, Qatar, Kuwait, Bahrain, Oman, Singapore

002138

50 Bags for Lollipops



087066 ●●●●●

9 Blisters lollipops "Licornes en vadrouille" and sticks for 45 prints 5 designs - Weight: ± 15 g - N/A: USA, China, Japan, UAE, Saudi Arabia, Qatar, Kuwait, Bahrain, Oman, South Korea, Singapore

061387 ●●●●●

9 Blisters lollipops "M. et M^{me} Teddy" and sticks for 45 prints 2 designs ø 5,5 cm
Weight: ± 15 g - N/A: USA, China, Japan, UAE, Saudi Arabia, Qatar, Kuwait, Bahrain, Oman, South Korea, Singapore

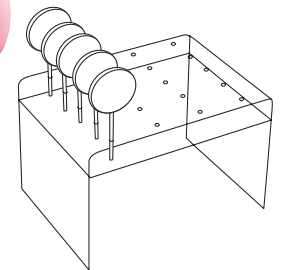

087034

9 Blisters lollipops "Super héros" and sticks for 45 prints 5 designs ø 5,5 cm - Weight: ± 15 g
N/A: USA, China, Japan, South Korea

070014 ●●●●●

9 Blisters lollipops "Licornes" and sticks for 45 prints 2 designs
H. 6 and 7,4 cm - Weight: ± 22 g • N/A: UAE, Saudi Arabia, Qatar, Kuwait, Bahrain, Oman

004560

1 Display for Lollipops for 20 pieces
25 x 18 cm - H. 16,5 cm

Free of colouring • Worldwide • Azo • Usable chocolates

KITS



QUENTIN
Bailly

- 040159
9 Blisters lollipops "Souvenirs d'enfance" and sticks for 45 prints
3 designs 2,6 x 8,5 cm - Th. 1,2 cm - Weight: ± 15 g



- 074166
9 Blisters lollipops "Les Dinos" and sticks for 45 prints 5 designs - Weight: ± 15 g



- 070389
9 Blisters lollipops "Jouets d'Antan" and sticks for 45 prints - 5 designs - Weight: ± 15 g



- 070238
9 Blisters lollipops "Bouche" and sticks for 45 prints 6,5 x 3,8 cm - Weight: ± 16 g



- 074165
9 Blisters lollipops "Fleurs" and sticks for 45 prints 3 designs - Weight: ± 15 g

- 060206
9 Blisters lollipops "Rêves de Licorne" and sticks for 45 prints 3 designs - Th. 1,3 cm Weight: ± 15 g

Free of colouring • Worldwide • Azo





🌿 060208
10 Moulds "Hiboux" for 5 pieces
10,7 x 12 cm - Th. 9,7 cm
Weight: ± 120 g



🌿 074103
12 Moulds "Licorne" for 6 pieces
11,4 x 12,5 cm - Th. 7,5 cm
Weight: ± 85 g



🌿 065089
10 Moulds "Renard sur son 31" for
5 pieces 11 x 12 cm - Th. 7,65 cm
Weight: ± 120 g



🌿 **NEW** 070427
8 Moulds Écureuil "Scrat" for 4 pieces
13,4 x 12,5 cm - Th. 7,5 cm
Weight: ± 100 g



🌿 087062
10 Moulds "Renard" for 5 pieces
8 x 13 cm - Th. 8 cm
Weight: ± 90 g



  **NEW** 087189

6 Moulds "Stylo" for 24 pieces

17,7 x 2,4 cm - Th. 2,3 cm

Weight: ± 20 g



These moulds are neutral.



NEW 074303
12 Moulds "Bol" for 12 pieces
ø 11 cm - Th. 5,6 cm - Weight: ± 80 g

NEW 074304
12 Moulds "Couvercle de bol" for
12 pieces ø 9,7 cm - Th. 0,4 cm
Weight: ± 25 g



NEW 074320
12 Moulds "Cagette"
for 6 pieces 13,6 x 7,8 cm
Th. 6 cm - Weight: ± 100 g



NEW 074117
15 Moulds "Cornets de glace Oh zut" for
5 pieces - Cornet: 5,4 x 11,6 cm - Ice-cream:
ø 8,2 cm - H. 4 cm - Weight: ± 60 g

CHRISTOPHE
Michalak



NEW 074080
16 Moulds "Van" for 6 pieces
19,4 x 7,2 cm - Th. 9 cm - Weight: ± 220 g

JULIEN
Boutonnet



045565
20 Moulds "Locomotive" for 4 pieces
15 x 12,5 cm H. 7 cm - Weight: ± 150 g



🌱 070424

12 Moulds "Teddy bear" for 4 pieces
8,6 x 13,4 cm - 2,8 x 6,4 cm - 2,4 x 5 cm
Th. 6,9 cm - Weight: ± 100 g

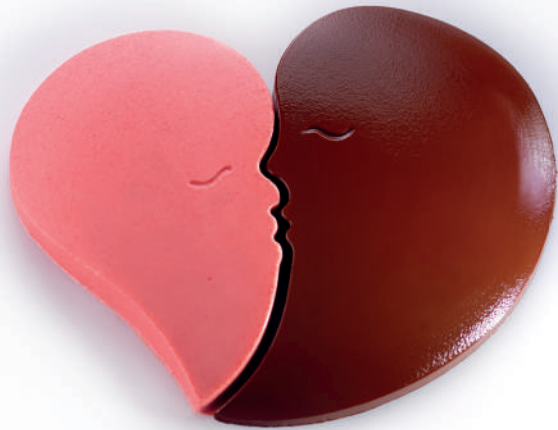

🌿 070422
10 Moulds "French Kiss" for 10 pieces
7,8 x 12,2 cm - 6,8 x 10,2 cm - Th. 2 cm
Weight: ± 180 g

FLORENT
Margaillan



🌿 025192
2 Moulds "Cœurs" for 8 pieces
15,5 x 6,2 cm - Weight: ± 70 g



🌿 074076
12 Moulds "Fleur" for 12 pieces ø 15 cm
Th. 1,6 cm - Weight: ± 210 g

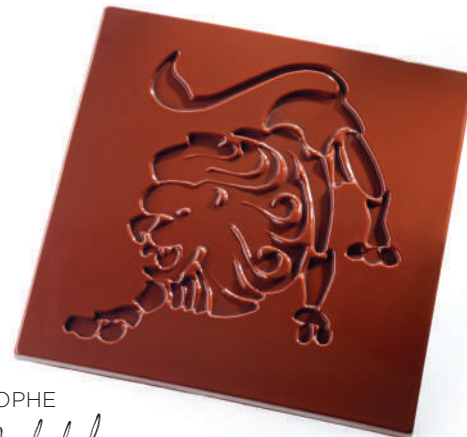

CHRISTOPHE
Michalak

🌿 009960
2 Moulds "Zodiaque" 12 designs
for 12 pieces 12 x 12 cm - Weight: ± 65 g

🌿 004429
Packing boxes for square cards

🌿 004432
100 bags for square cards



NEW 088185

24 Transfer sheets "Good vibes" for vinyls
3 designs ø 10,1 cm - N/A: USA, China, Japan, UAE,
Saudi Arabia, Qatar, Kuwait, Bahrain, Oman, South Korea

TRANSFER SHEETS & MOULDS FOR KITS

Discover the products which work on the same principle: one mould, a print to be put at the bottom.
 You just have to pour the chocolate and turn it out from the mould to obtain products
 which are fascinating by their illustrations and simplicity to make.
 If you do not have them yet, do not forget to order the moulds after having chosen your patterns...



070436 ● ● ●

24 Transfer sheets "Rock'n'Choc" for vinyls 6 designs ø 10,1 cm

N/A: USA, China, Japan, UAE, Saudi Arabia, Qatar, Kuwait, Bahrain, Oman, South Korea, Singapore



SEE INSTRUCTIONS ON
OUR WEBSITE

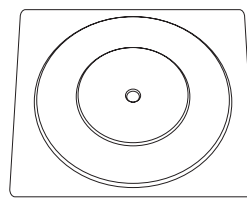

070428

12 Moulds Vinyle "33 Tours"
ø 19,6 cm - Weight: ± 120 g



070583

24 Paper sleeves for Vinyl and protective
films "33 Tours" 20 x 20 cm



061123 ● ● ●

10 Transfer sheets "Sur la plage" for bags 36,2 x 9,7 cm

N/A: China, Singapore

050117

4 Moulds "Sac" for 4 pieces
14 x 7 cm - H. 8 cm - Weight: ± 100 g



070188 ● ● ●

10 Transfer sheets "Best Chocolate" for mugs
25,35 x 11 cm

025191

4 Moulds "Mugs et anses" for 3 pieces
ø 8 cm - H. 10 cm - Weight: ± 75 g



PCB has developed a unique concept to easily make filled candies. Place the first half-shell blister sheet in the magnetic mould. The second blister sheet is placed in the other half of the mould. Pipe the filling of your choice into the half shells, remove the protective edge cover around the halfshell (no waste/no mess). Then simply close both sides of the magnetic mould together and leave to cool for 4 hours. This will give you wonderful decorated filled candies.

HALF-SHELLS TO FILL



SEE INSTRUCTIONS ON OUR WEBSITE



NEW 088201

630 Half-shells Eggs Dark choc "Lignes" 2,3 x 3,4 cm (to create 315 eggs) N/A: USA, China, Japan, UAE, Saudi Arabia, Qatar, Kuwait, Bahrain, Oman, South Korea



070175

630 Half-shells Eggs White choc "Traditionnels" 4 designs 2,3 x 3,4 cm (to create 315 eggs) • N/A: UAE, Saudi Arabia, Qatar, Kuwait, Bahrain, Oman

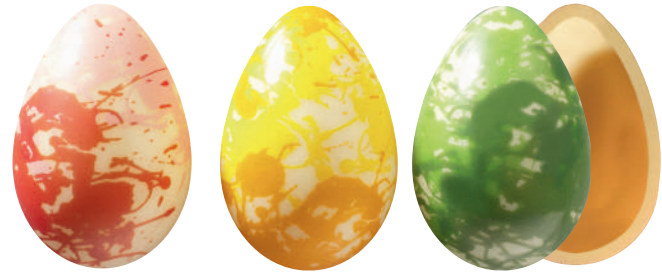

070174

630 Half-shells Eggs White choc "Taches" 3 designs 2,3 x 3,4 cm (to create 315 eggs) • N/A: China, UAE, Saudi Arabia, Qatar, Kuwait, Bahrain, Oman



NEW 088202

630 Half-shells Eggs White choc «Zen» 3 designs 2,3 x 3,4 cm (to create 315 eggs) N/A: USA, China, Japan, UAE, Saudi Arabia, Qatar, Kuwait, Bahrain, Oman, South Korea, Hong Kong

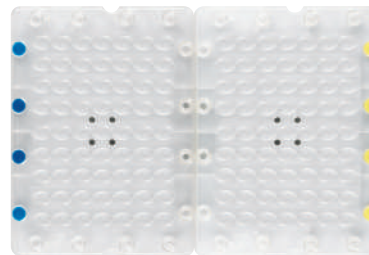

009964

1 Magnet form to make the filled eggs 63 prints 39,5 x 30 cm - H. 3 cm

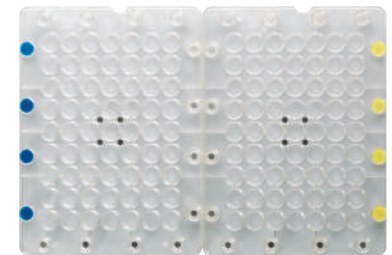

009963

1 Magnet form to make the filled balls 63 prints 39,5 x 30 cm - H. 3 cm

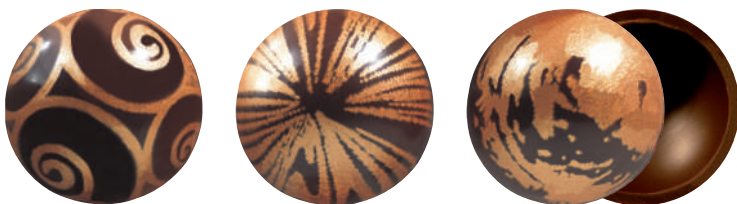

009025

630 Half-shells balls Dark choc "Éclat" 9 designs ø 2,6 cm - N/A: USA, China, Japan, UAE, Saudi Arabia, Qatar, Kuwait, Bahrain, Oman, South Korea

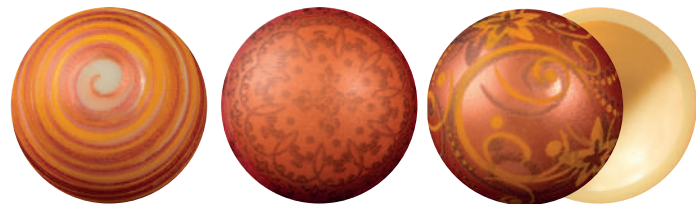

065216

630 Half-shells balls White choc "Tendance" 6 designs ø 2,6 cm N/A: USA, China, Japan, UAE, Saudi Arabia, Qatar, Kuwait, Bahrain, Oman, South Korea, Hong Kong

PCB has designed a full range of chocolate shells
that can be used for all manner of products:
Chocolate bonbons with extremely soft and delicate fillings.
The very thin shell allows enrobing after filling if desired.



SHELLS TO FILL

CHOCOLATE SHELLS



SUGGESTIONS
Make your Bonbons pop with some Kipettis P. 185



008991
 350 Round shells Dark choc
ø 2 cm - H. 1,2 cm



008988
 350 Square shells Dark choc
2,2 x 2,2 cm - H. 1,2 cm



008948
 504 Ball shells Dark choc ø 2,5 cm



008997
 350 Round shells Milk choc
ø 3 cm - H. 1,2 cm



009001
 350 Round shells White choc
ø 3 cm - H. 1,2 cm



008992
 350 Round shells Dark choc
ø 3 cm - H. 1,2 cm



009002
 280 Round shells White choc
ø 3 cm - H. 1,8 cm



008999
 280 Round shells Dark choc
ø 3 cm - H. 1,8 cm



008989
 350 Square shells Dark choc
2,7 x 2,7 cm - H. 1,2 cm



008990
 350 Square shells Dark choc
3 x 3 cm - H. 0,8 cm



009000
 280 Square shells Dark choc
2,7 x 2,7 cm - H. 1,8 cm



009013
 350 Rectangle shells Dark choc
3,4 x 1,6 cm - H. 1,4 cm



008998
 350 Oval shells Milk choc
3,4 cm - H. 1,2 cm



008993
 350 Oval shells Dark choc
3,4 cm - H. 1,2 cm



040097
 350 Round shells Choc BC
ø 3 cm - H. 1,2 cm



040099
 280 Square shells Choc BC
2,7 x 2,7 cm - H. 1,8 cm



040098
 280 Round shells Choc BC
ø 3 cm - H. 1,8 cm



SEE INSTRUCTIONS
ON OUR WEBSITE



POMPONS & POMPONETTES



CAUTION THESE PRODUCTS MUST BE FILLED AND FROZEN IN ORDER TO BE USED.

Pompoms and Pomponettes are the fruit of a technique invented and perfected by PCB: the extra-thin shells can be filled with a wide variety of mixtures then frozen. Then just turn out as needed.

These shells will sate any sweet or savoury craving.

The Pompoms can be filled with mousse or cake (like traditional entremets), ice-cream, coulis, cream cheese... Just freeze to create wonderful individual entremets that are already finely glazed and decorated. The thin shell is easily broken with a dessert spoon, making them so easy to enjoy.



009003

60 Dark Pompoms "Kougelhopf"
ø 7,2 cm - H. 3,5 cm
N/A: China



009024

60 White Pompoms
ø 7,2 cm - H. 3,5 cm



050067

60 Caramel pompoms
ø 7,2 cm - H. 3,5 cm - N/A: Taiwan



009010

60 Dark Pompoms "Traces" ø 7,2 cm
H. 3,5 cm - N/A: USA, China,
Japan, Qatar, South Korea



008971

210 Dark Pomponettes bronze printing
ø 3,4 cm - H. 1,4 cm
N/A: USA, China, Japan, Qatar, South Korea



008964

210 White Pomponettes bronze printing
ø 3,4 cm - H. 1,4 cm
N/A: USA, China, Japan, Qatar, South Korea



008985

60 Dark Pompoms "Arabesques"
ø 7,2 cm - H. 3,5 cm
N/A: USA, China, Japan, Qatar, South Korea





008949
48 Square shells Dark choc
4,6 x 4,6 cm - H. 4,5 cm



008950
54 Rectangles shells Dark choc
11,4 x 2,5 cm - H. 2,6 cm



061206
32 Dark choc Tubes "Étoiles" H. ± 8 cm - ø 3,3 cm



008644
36 Drop shells Dark choc "Ajourées"
9,5 x 5 cm - H. 4 cm



We are proud to represent real "Made in France" quality.

That's why we would like to propose this new range of tart shells. We have chosen to work with French partners and quality local products in order to better control traceability, limit the impact on the environment and above all stay in line with artisan craftsmanship. We want to highlight the purity of our carefully selected French ingredients (butter, flour, free range eggs...), and have removed all artificial flavourings and colourings that might interfere with the taste of your toppings.



SWEET TART SHELLS



043152
189 Mini chocolate rounds
ø 2,9 cm - H. 1,5 cm
N/A: China, Hong Kong



033526*
210 Small chocolate rounds
ø 3,7 cm - H. 1,5 cm
N/A: Canada



033527 *
210 Small chocolate squares
3,4 x 3,4 cm - H.1,5 cm
N/A: Canada



033528 *
36 Large chocolate rounds
ø 8 cm - H. 1,7 cm
N/A: Canada



033529*
36 Large chocolate squares
6,9 x 6,9 cm - H. 1,7 cm
N/A: Canada



043151
189 Mini sweet rounds
ø 2,9 cm - H. 1,5 cm
N/A: China, Hong Kong



033515*
210 Small sweet rounds
ø 3,7 cm - H. 1,5 cm
N/A: Canada



033520
90 Medium sweet rounds
ø 5 cm - H. 1,7 cm
N/A: China, Hong Kong



033517 *
210 Small sweet squares
3,4 x 3,4 cm - H. 1,5 cm
N/A: Canada

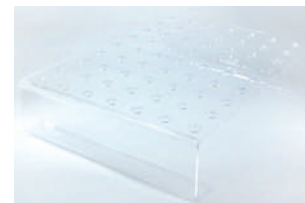

040192
Cones holder transparent 37 x 28 cm
H. 8 cm - 63 imprints



033522*
36 Large sweet rounds
ø 8 cm - H. 1,7 cm
N/A: Canada



033523
60 Large slim sweet rounds
ø 8 cm - H. 1 cm
N/A: China



033524 *
36 Large sweet squares
6,9 x 6,9 cm - H. 1,7 cm
N/A: Canada



033525*
90 Large sweet rectangles
10 x 3,5 cm - H. 1,7 cm
N/A: Canada



060893
189 Mini rounds Graham
ø 2,9 cm - H. 1,5 cm
N/A: China



060894
90 Medium rounds Graham
ø 5 cm - H. 1,7 cm
N/A: China



060895
36 Large rounds Graham
ø 8 cm - H. 1,7 cm
N/A: China



033521
90 Sweet cones ø 2,5 cm
H. 7,5 cm
N/A: USA, Canada



TART SHELLS



SAVOURY TART SHELLS

PLEASE NOTE THAT THOSE PRODUCTS ARE NOT AVAILABLE IN THE USA.

GLUTEN-FREE



033530 *
90 Medium gluten-free rounds
ø 5 cm - H. 2 cm - N/A: Canada,
China, Japan, Taiwan



033531 *
36 Large gluten-free rounds
ø 8,5 cm - H. 2 cm - N/A:
Canada, China, Japan, Taiwan

PUFF



NEW 087152 *
192 Small puff rounds
ø 4 cm - H. ± 2 cm
N/A: Canada



NEW 087153 *
80 Medium puff rounds
ø 6 cm - H. ± 2 cm
N/A: Canada



NEW 087154 *
36 Large puff rounds
ø 8,5 cm - H. ± 2 cm
N/A: Canada



060896
180 Casserole dish savoury
ø 5,1 cm - H. 1 cm
N/A: Canada



043150
189 Mini savoury rounds
ø 2,9 cm - H. 1,5 cm



033501 *
210 Small savoury rounds
ø 3,8 cm - H. 1,5 cm
N/A: Canada



033503 *
210 Small savoury squares
3,4 x 3,4 cm - H. 1,5 cm
N/A: Canada



033507*
36 Large savoury rounds
ø 8 cm - H. 1,7 cm
N/A: Canada



033508*
36 Large savoury squares
6,9 x 6,9 cm - H. 1,7 cm
N/A: Canada



033509*
90 Large savoury rectangles
10 x 3,5 cm - H. 1,7 cm
N/A: Canada

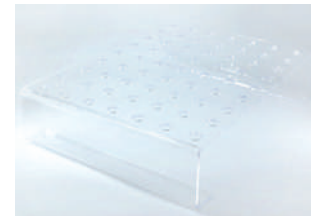

040192
Cones holder transparent 37 x 28 cm
H. 8 cm - 63 imprints



033506
90 Sesame cones
ø 2,5 cm - H. 7,5 cm
N/A: USA, Canada, Japan,
Hong Kong



033512*
192 Carrot tulips
ø 3,2 cm - H. 1,5 cm
N/A: Canada



033513*
192 Beetroot tulips
ø 3,2 cm - H. 1,5 cm
N/A: Canada



033514*
192 Spinach tulips
ø 3,2 cm - H. 1,5 cm
N/A: Canada



033511*
252 Barquettes neutral
6,9 x 3,3 cm - H. 0,9 cm
N/A: Canada



033510 *
252 Ebene savoury barquettes
6,9 x 3,3 cm - H. 0,9 cm
N/A: USA, Canada, China, South Korea



SILICONE MOULDS

PCB Création now has a specialised workshop to create your silicone moulds:

We create and shape unique silicone moulds for you in our new specialised design office where our expert team use state-of-the-art equipment. A new service developed with one goal: to make the unique accessible to you. No minimum order (from a mould to several thousand), affordable equipment costs, different processes available, adapted to your requests, and short production times (2 weeks to create your prototype and 4 to 5 additional weeks to manufacture your mould or moulds).



PCB Création silicone moulds are made in our factory in Alsace, using premium silicone, produced in Europe, with remarkable mechanical properties. It resists temperatures from -40°C to +220°C, and even more in some cases.

Our team takes all your requirements into account to provide you with a tailor-made solution perfectly adapted to your needs (moulds for logs, desserts - individual or for sharing- or even moulds for chocolate, plaques, stamps, etc.).



088266  
1 Silicone mould "Gobelet"
for 6 pieces
ø 6,7cm - H. 5,6 cm





087078  
1 Silicone mould "Vrille"
for 6 pieces
ø 7 cm - H. 4,5 cm

THE + OF SILICONE MOULDS



- A WIDE VARIETY OF SHAPE DESIGN OPTIONS
- SUITABLE FOR COOKING AND FREEZING
 - VERY RESISTANT
- EASY TO REMOVE FROM THE MOULD
 - MADE IN FRANCE
 - REUSABLE



NEW **088265**  
1 Silicone mould "Petite tarte"
for 6 pieces
ø 7,4 mm - H. 1,7 cm

JEAN-PHILIPPE
Darcis





NEW **088196**  
1 Silicone mould "Étoile"
for 6 pieces
ø 7,5 cm - H. 4,5 cm



MARC
Rivière



NEW **088195**  
1 Silicone mould "Torsade"
for 24 pieces
ø 3 cm - H. 1,7 cm

SILICONE MOULDS







010276  
1 Silicone mould "Palet" for 8 pieces
ø 6,5 cm - H. 3 cm





010176  
1 Silicone mould "Mini wedding cake"
for 6 pieces ø 7,5 cm - H. 6 cm



010051  
1 Silicone mould "Bouchon de parfum"
for 1 piece
010297  
1 Silicone mould "Parfum" for
6 pieces ø 8 cm H. 4 cm





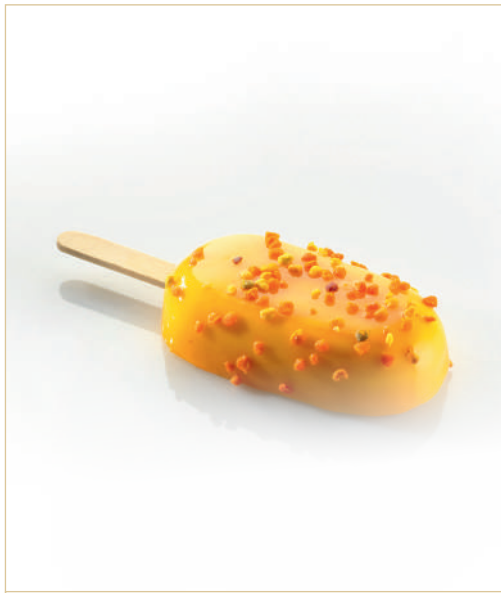

010274  
1 Silicone mould "Ovoïde"
for 8 pieces
8,2 x 4,3 cm - H. 3,2 cm





010119  
1 Silicone mould "Mini magnum"
for 8 pieces 6,8 x 3,7 cm Th. 1,8 cm
004667  
50 Mini flat birch sticks 7,2 x 0,8 cm



010120  
2 Silicone moulds "Magnum"
for 12 pieces 9,2 x 4,8 cm Th. 2,5 cm
004668  
50 Flat birch sticks 11,2 x 1 cm



NEW 088197  

1 Silicone mould "Étoile"
for 1 piece
ø 19,5 cm - H. 5 cm

JEAN-PHILIPPE
Darcis

(045647 - Stars Crystallized
+ 088208 - Small freeze-dried
rose petals "Violet" + 010426
Crunchies purple)



TEARABLE MOULDS

Since 2021, our range has also included tear-off dessert moulds with either classic or more daring designs.

These moulds are ideal for protecting your desserts when stored in the freezer.
Simply pull the tab to tear the mould open and remove your dessert from the mould.

ROUNDED SQUARES



JULIEN
Alvarez

4 CM

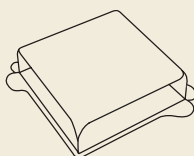

070564

100 Entremets moulds
"Carré plat arrondi"
for 100 pieces
14 x 14 cm - H. 4 cm
Tearable moulds

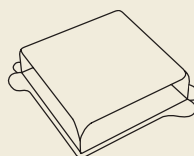

070565

100 Entremets moulds
"Carré plat arrondi"
for 100 pieces
16 x 16 cm - H. 4 cm
Tearable moulds

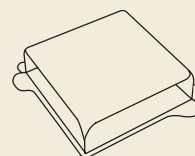

070566

100 Entremets moulds
"Carré plat arrondi"
for 100 pieces
18 x 18 cm - H. 4 cm
Tearable moulds

THE + OF TEARABLE MOULDS

- AFFORDABLE
- SUITABLE FOR FREEZING
- EASY TO REMOVE FROM THE MOULD
- MADE IN FRANCE

CLASSIC ROUNDS



	14 CM	16 CM	18 CM	20 CM
4 CM	<p>070552 100 Entremets moulds "Rond plat" for 100 pieces ø 14 cm - H. 4 cm Tearable moulds</p>	<p>070553 100 Entremets moulds "Rond plat" for 100 pieces ø 16 cm - H. 4 cm Tearable moulds</p>	<p>070554 100 Entremets moulds "Rond plat" for 100 pieces ø 18 cm - H. 4 cm Tearable moulds</p>	<p>070555 100 Entremets moulds "Rond plat" for 100 pieces ø 20 cm - H. 4 cm Tearable moulds</p>
4,5 CM	<p>070556 100 Entremets moulds "Rond plat" for 100 pieces ø 14 cm - H. 4,5 cm Tearable moulds</p>	<p>070557 100 Entremets moulds "Rond plat" for 100 pieces ø 16 cm - H. 4,5 cm Tearable moulds</p>	<p>070558 100 Entremets moulds "Rond plat" for 100 pieces ø 18 cm - H. 4,5 cm Tearable moulds</p>	<p>070559 100 Entremets moulds "Rond plat" for 100 pieces ø 20 cm - H. 4,5 cm Tearable moulds</p>

ROUNDED ROUNDS

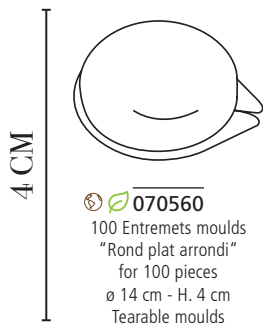
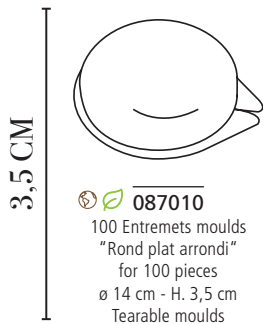
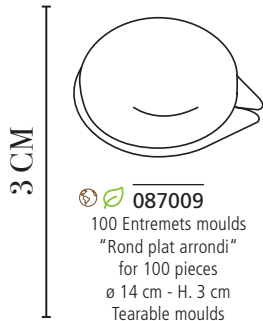

ROUNDED EGGS



ÉTIENNE
Leroy

4 CM	12 X 19 CM	16,2 X 24 CM
	<p>🌿 074074 30 Entremets moulds "Œuf 4 personnes" for 30 pieces 12 x 19 cm - H. 4 cm Tearable moulds</p>	<p>🌿 074075 30 Entremets moulds "Œuf 6 personnes" for 30 pieces 16,2 x 24 cm - H. 4 cm Tearable moulds</p>

TART TOPS



THIERRY
Barnas

15 CM	17 CM	18 CM	19 CM
<p>🌿 070567 30 Entremets moulds "Dessus de tarte" for 30 pieces ø 15 cm - H. 1,8 cm Tearable moulds</p>	<p>🌿 070568 30 Entremets moulds "Dessus de tarte" for 30 pieces ø 17 cm - H. 1,8 cm Tearable moulds</p>	<p>🌿 087075 30 Entremets moulds "Dessus de tarte" for 30 pieces ø 18 cm - H. 2 cm Tearable moulds</p>	<p>🌿 070569 30 Entremets moulds "Dessus de tarte" for 30 pieces ø 19 cm - H. 1,8 cm Tearable moulds</p>

ENVELOPE



3,5 CM	20,5 X 14 CM
	<p>🌿 070514 30 Entremets moulds "Lettre" for 30 pieces 20,5 x 14 cm - H. 3,5 cm Tearable moulds</p>

SPIRAL



YANN
Bry

1,5 CM	18 CM
	<p>🌿 060224 10 Entremets moulds "Spirale" for 10 pieces ø 18 cm - H. 1,5 cm Tearable moulds</p>

INDIVIDUAL ENTREMETS MOULDS

Reusable and freezable, these moulds allow you to remove your desserts with ease.

We have in fact designed a "support jamb" around most of our reusable moulds which you can pour hot water into in order to remove your desserts more easily. **As such, your desserts will be easy to remove from the mould.**

Our range includes individual moulds, dessert moulds and yule log moulds.

In search of exclusivity? Our team is at your service to offer you a customised solution that best matches your needs.

Do not hesitate to contact us to discuss your customised projects.

🌱 070546
30 Entremets moulds
"Charlotte" for 120 pieces
8 x 8,3 cm - H. 3,2 cm
Moulds with support jams



ENTREMETS MOULDS

ARNAUD

Lahver



🍷 010241

4 Entremets moulds
"Tong" for 48 pieces
12,5 x 5,7 cm - H. 1 cm

🍷 010242

1 Cookie cutter "Tong"
12,9 x 6,1 cm

🍷 001667

4 Blisters "Lanière de
tong" so 48 prints
5,1 x 5,3 cm

🍷 004435

100 Small cardboards
"Tong"

PASCAL

Molines



🍷 009790

10 Molines tubes 58 cm - ø 3,5 cm and 20 covers
100 Rhodoïde sheets neutral 58 x 12 cm

🍷 005002

100 Rhodoïde sheets neutral 58 x 12 cm

SÉBASTIEN

Bouillet



🍷 009941

10 Entremets tubes "Sucettes" ø 3,5 cm - H. 8 cm

🍷 005013

200 Rhodoïde sheets neutral 12 x 8 cm

🍷 004568

200 Flat beech sticks 9,3 x 1,8 cm

JOHAN

Martin



🍷 070550

30 Entremets moulds
"French Donut" for 150 pieces
ø 8 cm - H. 1,9 cm
Moulds with support jamba

🍷 070551

30 Entremets moulds "Dôme"
for 120 pieces ø 6,8 cm - H. 4 cm
Moulds with support jamba

THIERRY

Mulhaupt



🍷 010354

1 Tray for individual entremets "Ronds"
for 45 pieces ø 6 cm - H. 4 cm

🍷 005000

200 Rhodoïde sheets neutral 19,5 x 4 cm



ENTREMETS MOULDS



🌿 074060

30 Entremets moulds "Petite tarte rose"
for 120 pieces ø 7,4 cm - H. 2 cm

🌿 070536

30 Entremets moulds "Palet"
for 150 pieces ø 8 cm - H. 1,7 cm
Moulds with support jams



🌿 074059

30 Entremets moulds "Petite tarte fleur"
for 120 pieces ø 7,4 cm - H. 1,7 cm
Moulds with support jams

🌿 070536

30 Entremets moulds "Palet"
for 150 pieces ø 8 cm - H. 1,7 cm
Moulds with support jams



🌿 070520

30 Entremets moulds "Petite tarte"
for 120 pieces ø 7,4 cm - H. 1,7 cm
Moulds with support jams

🌿 070536

30 Entremets moulds "Palet"
for 150 pieces ø 8 cm - H. 1,7 cm
Moulds with support jams



🌿 070535

30 Entremets moulds "Petite tarte pochage"
for 120 pieces ø 7,4 cm - H. 2,3 cm
Moulds with support jams

🌿 070536

30 Entremets moulds "Palet"
for 150 pieces ø 8 cm - H. 1,7 cm
Moulds with support jams

YANN

Brys



🌿 060221

16 Entremets moulds "Spirale"
for 48 pieces ø 8 cm - H. 1,5 cm

🌿 070536

30 Entremets moulds "Palet"
for 150 pieces ø 8 cm - H. 1,7 cm
Moulds with support jams



🌿 070534

30 Entremets moulds "Petite tarte meringuée"
for 120 pieces ø 7,4 cm - H. 2,7 cm
Moulds with support jams

🌿 070536

30 Entremets moulds "Palet"
for 150 pieces ø 8 cm - H. 1,7 cm
Moulds with support jams

ENTREMETS MOULDS



 **NEW** 088188

30 Entremets moulds "Noisette 4 personnes"
for 30 pieces 14 x 14,5 cm - H. 4 cm
Moulds with support jams

 **NEW** 088189

30 Entremets moulds "Noisette 6 personnes"
for 30 pieces 17 x 18 cm - H. 4 cm
Moulds with support jams

CAMILLE

Le Secq



🌱 070517

30 Entremets moulds "Souche"
for 30 pieces ø 18 cm - H. 4 cm
Moulds with support jamba

VINCENT

Guerlais



NEW 087061

60 Entremets moulds
"Panama" for 30 pieces
Top: 12,7 x 15 cm - H. 7 cm
Moulds with support jamba
Bottom: 21 x 21 cm - H. 1,3 cm
Moulds with support jamba



SEE THE COMPLETE LINE
OF MOULDS P. 312



🌱 070513

30 Entremets moulds "St Honoré"
for 30 pieces ø 16 cm - H. 6 cm

JÉRÉMY

Del Val



🌱 074236

30 Entremets moulds "Candy"
for 30 pieces ø 17 cm - H. 4 cm
Moulds with support jamba



Gabriel le Bouang

🍷 🌿 **074072**

10 Entremets moulds
"Cadre Pâtissier" for
10 pieces 57 x 37 cm
H. 3,5 cm

🍷 🌿 **070584**

10 Entremets moulds
"Cadre Pâtissier" for
10 pieces 57 x 37 cm
H. 4 cm

🍷 🌿 **074073**

10 Entremets moulds
"Cadre Pâtissier" for
10 pieces 57 x 37 cm
H. 4,5 cm

ENTREMETS MOULDS

JOFFREY

Lafontaine



🌿 070521
30 Entremets moulds "Vrille"
for 30 pieces ø 17 cm - H. 9,5 cm
Moulds with support jams

🌿 070542
30 Entremets moulds "Vrille"
for 30 pieces ø 14 cm - H. 7 cm
Moulds with support jams

THIERRY

Barnas



🌿 074071
30 Entremets moulds "Fleur"
for 30 pieces 16 x 17 cm - H. 4 cm
Moulds with support jams

JÉRÔME

De Oliveira



🌿 070541
30 Moules "Rose" (top)
for 30 pieces ø 15 cm - H. 1,2 cm
Moulds with support jams



🌿 070537
30 Entremets moulds "Rosace"
for 30 pieces ø 15 cm - H. 1,5 cm
Moulds with support jams

JULIEN

Alvarez



🌿 060881
2 Rectangle Moulds "Cake" for 1 piece
25 x 7 cm - H. 7 cm

🌿 060880
100 Transfer sheets "Marbre noir"
for 20 cakes 6,9 x 6,9 cm
6,9 x 25 cm



🌿 070518
30 Entremets moulds
"Demi-sphère" for 30 pieces
ø 14 cm - H. 7 cm
Moulds with support jams

🌿 070522
30 Entremets moulds
"Demi-sphère" for 30 pieces
ø 18 cm - H. 9 cm
Moulds with support jams

ENTREMEMETS

PASCAL
Niau



🌿 010294
10 Structure sheets "Rondin"
56,5 x 36,5 cm

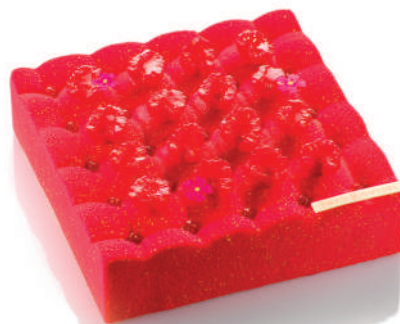

🌿 009808
10 Structure sheets "Matelassé"
56,5 x 36,5 cm



🌿 009836
10 Structure sheets
"Mouvance"
56,5 x 36,5 cm

🌿 060153
10 Structure sheets
"Mouvance" for yule
log 52,7 x 17,7 cm



🌿 060888
10 Structure sheets "Feuillage" 56,5 x 36,5 cm



🌿 009741
10 Structure sheets "Ondulé" 56,5 x 36,5 cm



🌿 065067
10 Structure sheets
"Écorce" for yule log
52,7 x 17,7 cm

🌿 074351
10 Structure sheets
"Écorce"
56,5 x 36,5 cm



🌿 036161
10 Structure sheets
"Déstructuré"
56,5 x 36,5 cm

🌿 060152
10 Structure sheets
"Déstructuré" for yule
log 52,7 x 17,7 cm



🌿 060887
10 Structure sheets
"Pyramide"
56,5 x 36,5 cm

🌿 065068
10 Structure sheets
"Pyramide" for yule log
52,7 x 17,7 cm



🌿 060886
10 Structure sheets
"Bulles"
56,5 x 36,5 cm

🌿 060155
10 Structure sheets
"Bulles" for yule log
52,7 x 17,7 cm

🌿 Free of colouring 🌍 Worldwide • Azo



🌿 009891
10 Structure sheets "Petit Matelassé"
56,5 x 36,5 cm

🌿 060156
10 Structure sheets "Petit Matelassé"
for yule log 52,7 x 17,7 cm

STRUCTURE SHEETS FOR ENTREMETS



These structure sheets have been specially created to be used with our moulds "Cadre pâtissier" (070584-074072-074073 P. 248) and moulds "Standard Yule log" (070587 P. 105).

ANTHONY
Terrone

🌿 000368
10 Structure sheets "Ananas" 56,5 x 36,5 cm

🌿 060154
10 Structure sheets "Ananas" for yule log
52,7 x 17,7 cm

JÉRÔME

De Oliveira



🌿 074289
10 Structure sheets "Fleurs" 56,5 x 36,5 cm



SEE INSTRUCTIONS ON OUR WEBSITE



🌿 060889
10 Structure sheets "Envol" 56,5 x 36,5 cm

🌿 065066
10 Structure sheets "Envol" for yule log
52,7 x 17,7 cm

TRANSFER SHEETS FOR ENTREMETS



SEE INSTRUCTIONS
ON OUR WEBSITE



This entremets was made with the structure sheets "Écorce" 074351 (p. 250)



NEW 087192

20 Transfer sheets "Rondin" for entremets 26 x 26 cm N/A: USA, China, South Korea

CHOCOLATE STRIPS

These chocolate strips can be used like the classic rolls. All you need to do is surround the inside of your mould with this strip and fill in your cream desserts as usual, to obtain an ideal decoration with an incredible thinness.

PASCAL

Niau



061401

15 Chocolate strips "Fraises" - 66 x 4 cm - N/A: China, Japan

TRANSFER SHEETS FOR YULE LOG



060127

25 Transfer sheets "Rayures" for yule log 52,7 x 17,7 cm
N/A: China, Taiwan



060125

25 Transfer sheets "Taiga" for yule log 52,7 x 17,7 cm
N/A: USA, China, Japan, UAE, Saudi Arabia, Qatar, Kuwait, Bahrain, Oman, South Korea



060126

25 Transfer sheets "Acidulée" for yule log 52,7 x 17,7 cm
N/A: USA, China, Singapore

BAKING PAPER



070221



20 Baking paper sheets "Faux bois" 60 x 40 cm



061400

20 Baking paper sheets "Marbré" 60 x 40 cm



070222

20 Baking paper sheets "Savane" 60 x 40 cm
N/A: China, Taiwan

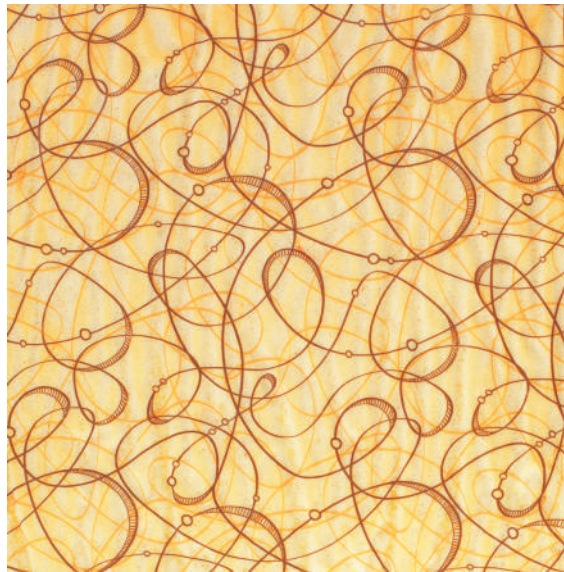

060129

20 Baking paper sheets "Poursuite" 60 x 40 cm
N/A: USA, China, Japan, South Korea



In order to obtain an even more fabulous result, we have created a compound: "Sublimasse" which once hydrated, will be applied over the baking sheet prior to your biscuit.

This product prevents the appearance of air bubbles on the surface of your biscuit and also allows your biscuit to be more airy.

SEE INSTRUCTIONS
ON OUR WEBSITE



010384

Sublimasse nature - 900 g
N/A: USA, Canada, Japan, UAE,
Saudi Arabia, Qatar, Kuwait,
Bahrain, Oman, South Korea,
Taiwan, Singapore,



Free of colouring



Worldwide • Azo



INGREDIUM

INGREDIUM RANGE

The INGREDIUM range consists of four product categories:

Texturisers, Acids & Salts, Emulsifiers & Stabilisers, Sugars & Derivatives

INGREDIUM represents a wide range of solutions carefully selected and formulated by our Research & Development team, in close collaboration with Chefs and pastry Chefs, to meet your needs and open up an infinite universe of creation.

Explore endlessly, use and abuse this new range to bring to life your most breathtaking creations!



In order to provide you with the best possible support, we place our skills and state-of-the-art equipment at your disposal to develop or adapt your recipes with products from the INGREDIUM range. **Contact our customer service (+33 (0)3 88 587 333) who will direct you to the team dedicated to this personalised service.**



Flash this QR code and find the whole range, and our recommendations for use.
Or go directly to our website: <https://www.pcb-creation.com/nos-collections/ingredium/>



Plant-based origin

Product made with plant-based raw materials.



Ingredient declaration

Product without additives that can be declared as an ingredient.



TEXTURIZERS

Bring all your creations to life and create different textures with our technical ingredients for **jellifying**, **thickening** and **stabilising**.

FIBRES: replace additives without compromising taste thanks to the jellifying, thickening and stabilising properties of these plant-based ingredients.





 **NATUR LIN** (Linseed vegetable fiber powder)
 **087084** - 200 g
 **074347** - 900 g



 **NATUR AGRUM** (Citrus fiber powder)
 **087083** - 200 g
 **074348** - 500 g
 N/A: USA



The "additive-free" plant-based alternative for hot jellifying (e.g. fruit paste).

 **NATUR ALG** (Gracilaria seaweed powder)
 **087088** - 200 g
 N/A: USA, Japan, South Korea

PROTEINS: replace liquid egg white with a powdered version or a plant-based alternative: for your meringues, macaroons, mousses. Or even replace the whole egg.





ALBUMEN (Pasteurised egg albumen powder)
074349 - 400 g
 N/A: USA



 **NATUR AIR** (Potato protein powder)
 **087082** - 200 g
 **074346** - 400 g



The plant-based alternative to whole eggs for sweet and savoury creations

 **NEW** **NATUR EGGLESS** (Starch and protein-based powder preparation)
 **088204** - 900 g
 N/A: Hong Kong

NEW!





PROBLEMATIC	SOLUTION	EXAMPLES
REPLACE EGG WHITE	NATUR AIR	PLANT-BASED MACAROONS
REPLACE JELLIFYING ADDITIVES (AGAR, PECTINE, CARRAGEENANS)	NATUR ALG	FRUIT PASTE WITHOUT ADDITIVES
REPLACE GELATINE WITH A PLANT-BASED INGREDIENT	NATUR ALG	PLANT-BASED MOUSSE
REPLACE THICKENING AND STABILISING ADDITIVES (FREEZING)	NATUR LIN	COLD SAUCE WITHOUT ADDITIVES
REPLACE TEXTURIZING ADDITIVES (MODIFIED STARCH, PECTIN)	NATUR AGRUM	FRUIT "CRÉMEUX" WITHOUT ADDITIVES
REPLACE ADDITIVES TO STABILISE FROZEN DESSERTS	NATUR AGRUM + NATUR LIN	ADDITIVE-FREE ICE CREAM
REPLACE WHOLE EGGS WHILE RETAINING THEIR COAGULATIVE PROPERTIES	NATUR EGGLESS	EGG-FREE FLAN

GELATINS: thanks to their jellifying properties, they can be used in all your preparations and come from a range of animal sources (fish, pork or beef).



INGREDIUM



✔ **GELATIN F**
 (Fish gelatin)
060641 - 1 kg
087089 - 12 kg



✔ **GELATIN B**
 (Bovine gelatin)
060642 - 1 kg
087090 - 12 kg
N/A: UAE, Saudi Arabia, Qatar, Kuwait, Bahrain, Oman



✔ **GELATIN P**
 (Pig gelatin)
060648 - 1 kg
087091 - 12 kg
N/A: USA, Canada, UAE, Saudi Arabia, Qatar, Kuwait, Bahrain, Oman



✔ **GELATIN FAST**
 (Instant bovine gelatin powder)
087087 - 500 g
N/A: Canada, UAE, Saudi Arabia, Qatar, Kuwait, Bahrain, Oman

Time-saving gelatin: it can be applied directly to the preparation without being heated or pre-hydrated.

PECTINS: whether for acidic, sweet or calcium-rich preparations, each of our pectins will suit your creations.

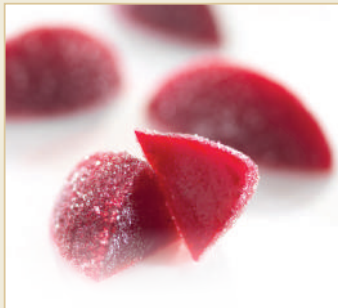

✔ **PECTINE YELLOW**
 (Pectins)
060626 - 1 kg
N/A: China, Japan, Taiwan



✔ **PECTINE CA** (Pectins)
060628 - 1 kg
N/A: Japan



✔ **PECTINE NHX** (Pectins)
060627 - 1 kg
N/A: China, Japan

Pectin for a **variety of uses:** toppings, mousses, creams, fruity inserts, etc.

STARCHES: for quick and easy thickening, hot or cold.



✔ **COLDTEX**
 (Modified potato starch)
060632 - 1 kg
N/A: USA



✔ **WARMTEX**
 (Corn starch)
060636 - 800 g
N/A: USA



✔ **COLDTEX+** (Modified tapioca starch)
060616 - 500 g
N/A: USA, Canada

Instant cold thickener for fruit or plant-based purées



Plant-based



Ingredient declaration

ALGAE, GUM AND METHYLCELLULOSE DERIVATIVES

a wide variety of thickening agents of plant-based origin to choose from depending on the desired texture and use.

INGREDIUM



AGAR (Agar)
060643 - 700 g
N/A: Japan, South Korea, Taiwan

ALGINAT
(Sodium alginate)
NEW 088264 - 200 G
060629 - 1 kg

KAPPA (Carrageenan)
060630 - 800 g
N/A: Japan

IOTA (Carrageenan)
060631 - 1 kg
N/A: Japan



ACACIA
(Acacia gum)
060614 - 500 g

XANTHAN
(Xanthan gum)
087079 - 200 g
060615 - 1 kg
N/A: Japan

CAROUBE
(Locust bean gum)
065306 - 800 g
N/A: Japan

GUAR (Guar gum)
060622 - 1 kg
N/A: Japan

GELLAN (Gellan gum)
087080 - 200 g
060635 - 700 g
N/A: Japan

METHYL-GEL
(Methylcellulose)
060623 - 400 g

ACIDS & SALTS

Their acidifying, antioxidant, mineralising and acidity-modulating properties will provide that little extra needed to **jellify** certain texturing agents or allow you to **subtly balance** the **flavour profile** of your creations.



CITRIX (Citric acid)
060620 - 1 kg

ASCORBIX
(Ascorbic acid)
060621 - 1 kg
N/A: USA

CALCIUM CL
(Calcium chloride dihydrate)
060638 - 1 kg
N/A: USA, Singapore

CALCIUM LA
(Calcium lactate)
060639 - 1 kg
N/A: USA, China

SODIUM CI
(Sodium citrates)
060640 - 1 kg
N/A: USA

NEW **BAKING POWDER**
(Baking powder)
088268 - 1 kg
N/A: USA, Canada



Plant-based



Ingredient declaration

EMULSIFIERS & STABILIZERS

Emulsifying and **stabilising** properties will optimise storage-life and stabilise your preparations and frozen desserts.

EMULSIFIERS: to emulsify according to the base of use (aqueous or fatty) and according to your plant-based origin preferences (soya or sunflower).



 **EMUL O**
(Sucrose esters of fatty acids)
060644 - 1 kg
N/A: Canada



 **EMUL F** (Mono- and diglycerides of fatty acids)
060634 - 800 g



 **EMUL A**
(Sunflower lecithin)
060645 - 600 g
N/A: USA



 **EMUL S** (Soy lecithin)
087081 - 200 g
060649 - 600 g
N/A: USA

A **must-have** for **emulsifying** ganaches or caramels or for creating those last-minute mousses.

STABILISERS: optimise the texture and conservation of your ice creams and sorbets to ensure optimum quality during tasting.



SORBBIUM (Blend of sorbet stabilizers)
061391 - 800 g
N/A: USA, Japan

A combination of texturizers to improve the **stabilisation, whipping, melting speed and texture** of sorbets



ICREMIUM (Blend of ice cream texturizers)
061392 - 800 g
N/A: USA, Japan, Taiwan

A combination of texturizers to improve the **stabilisation, whipping, melting speed and texture** of ice creams



SUGARS & DERIVATIVES

Their diverse sweetening, structuring and colouring properties when cooked, which allows you to diversify your recipes and **reduce their sugar** content while **preserving the richness of taste** and aroma of your sweet creations.

TECHNICAL SUGARS:



- DEXTROSE (Dextrose)
- 060618 - 1 kg
- 087093 - 10 kg



- GLUCOSE P
- (Dried glucose syrup)
- 060633 - 1 kg
- 087094 - 10 Kg
- N/A: USA



- NEW** NEIGE DECOR
- (Preparation for pastry decoration)
- 088269 - 800 g
- 088270 - 5 Kg
- N/A: USA, Canada, Japan, Hong Kong

SUGAR DERIVATIVES:



- MALTO (Maltodextrin)
- 060617 - 600 g
- 087092 - 9 Kg



- MALTO DRY
- (Tapioca maltodextrin)
- 060619 - 500 g
- N/A: USA

POLYOLS:



- MALTITOL (Maltitol)
- 060625 - 1 kg
- N/A: USA, Japan, Hong Kong



- SORBITOL (Sorbitol)
- 060624 - 1 kg
- 087096 - 12 Kg
- N/A: USA, Hong Kong



- ISOMALT (Isomalt)
- 060647 - 1 kg
- 004488 - 5 kg
- 087097 - 15 kg
- N/A: Japan, Hong Kong

FIBRES:



- INULIN (Inulin)
- 060637 - 800 g
- 087095 - 10 Kg
- N/A: China



- NEW** NATUR SWEET
- (Dietary fiber (fructooligofructose))
- 088203 - 900 g

SCALE OF SWEETENING POWER

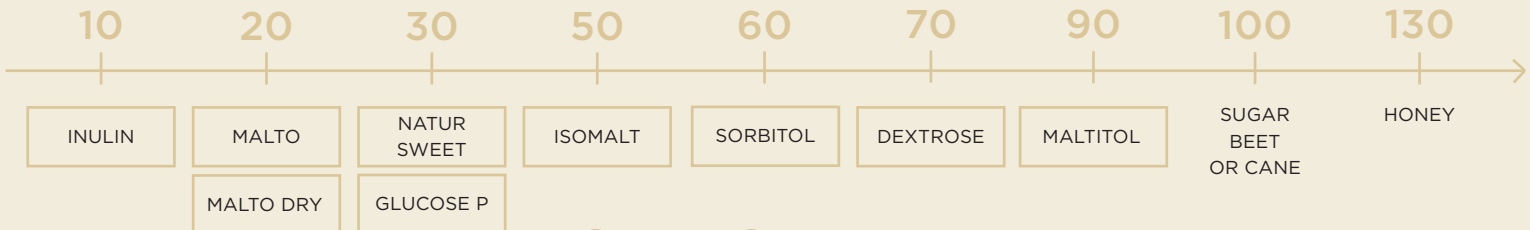

Plant-based



Ingredient declaration

100% FRUIT / VEGETAL POWDERS

POWDERS



045004
Barley grass powder (gluten-free)
200 g - N/A: USA



050226
Passion fruit powder - 200 g
N/A: Japan



045000
Strawberry powder - 200 g
N/A: USA, Taiwan



045003
Mango powder - 200 g



045001
Raspberry powder - 200 g - N/A: USA



074338
Hibiscus powder - 200 g - N/A: USA



045002
Blackcurrant powder - 200 g - N/A: USA



065302
Black cocoa powder - 200 g - N/A: USA



060646
Matcha powder - 200 g - N/A: USA

AS A GUIDELINE: FOR 1KG OF CHOCOLATE

POWDER	PCB recommendation	Legal limit*
Strawberry	50 g	55 g
Raspberry	50 g	95 g
Blackcurrant	50 g	133 g
Hibiscus	30 g	33 g
Mango	50 g	111 g
Barley grass	50 g	83 g
Passion fruit	50 g	175 g
Matcha	50 g	100 g

* Maximum dosage allowed by European regulations in the case where only the fruit powder in question is added to chocolate. Any other ingredient added to the chocolate must be counted in addition to the fruit powder in the calculation of the maximum permitted dosage.

PIECES & CRISPY

PIECES



045005
Strawberry pieces - 80 g - N/A: Taiwan



045006
 Raspberry pieces - 80 g



050225
 Whole raspberries - 60 g

CRISPY



060951
Coco Crispy - 150 g - N/A: USA



060949
Strawberry Crispy - 200 g - N/A: USA, Taiwan



060950
Raspberry Crispy - 200 g - N/A: USA



070589
Lime Crispy - 180 g - N/A: USA

CRISPY WETPROOF



NEW 088141
Strawberry Crispy wetproof - 400 g
N/A: Taiwan



NEW 088142
 Raspberry Crispy wetproof - 400 g



NEW 088143
 Lime Crispy wetproof - 350 g

Ideal for bringing texture with a **pure taste of fruit, moisture resistant**, they can be used in decoration or even in inclusion, topping...

NEW!

A close-up photograph of a single, round chocolate truffle. The truffle is dark brown with a glossy finish and is decorated with several small, irregular pieces of gold leaf. It is mounted on a dark brown, ruffled-edged circular base. A small, rectangular, dark brown nameplate is attached to the front of the truffle, featuring the name "FLORENCE LESAGE" in white, uppercase, sans-serif font. The background is a dark, out-of-focus field of numerous golden bokeh lights, creating a warm and elegant atmosphere. The lighting is soft, highlighting the texture of the chocolate and the shimmer of the gold leaf.

FLORENCE LESAGE

INCLUSIONS

FLOWER CHIPS



008695

Violet chips - 250 g
N/A: USA, China, Japan, South Korea



008693

Rose chips - 250 g
N/A: USA, China, Japan

COCOA NIBS



060948

Cocoa nibs - 350 g

CRUNCHY BALLS



010440

Crunchies dark - 500 g
N/A: Canada, China, Japan



070314

Uncoated crunchy balls gluten-free
1,2 kg - N/A: Canada

MERINGUETTES



060953

Meringuettes coated white chocolate
350 g - N/A: China, Japan



060952

Meringuettes egg-free - 250 g

KIPETTIS



004638

Kipetti nature - 1 kg
N/A: USA

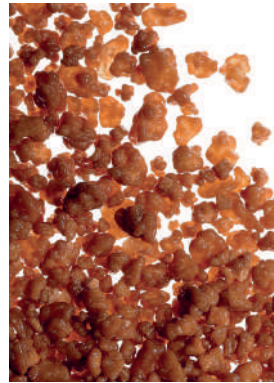

004557

Kipetti coated - 1 kg
N/A: USA

CARAMEL CHIPS



060954

Caramel chips - 350 g



004628

Isigny Caramel chips - 250 g



UNDERSTANDING COLOUR

Colouring: how does it work?

Discover through this table the multiple coloring possibilities offered by the products of our range, and their specificities.

	POWDERS & 100% FRUIT/ VEGETABLE PIECES	FOOD COLOURING	NATURAL DYES	SYNTHETIC DYES
DESCRIPTION	" Natural" colouring solutions extracted from vegetable, mineral or animal sources use transformation processes which respect the original raw material and result in rather significant concentrations of pigment.			Concentrated food colouring derived from pigments produced by synthesis and purification. These pigments cannot usually be found in nature.
	Materials produced as a result of a simple physical transformation (freeze-drying, grinding) of fruit and vegetables.	Materials produced by non-selective extraction from fruit, vegetables or plants.	Materials produced by selective extraction from vegetable, mineral or animal sources.	
TASTE*	Typical taste	Slight taste possible	Little taste	No taste
COLOUR INTENSITY**	Light	Medium intensity	Intense to very intense	Intense to very intense
DECLARATION STATEMENT***	No additives (Ingredient)	No additive (Food colouring: ingredient)	Additive E Number present in colouring	Additive E Number present in colouring
LIMITED QUANTITY***	No (except for use with chocolate)	No (except for use with chocolate)	Yes	Yes
POSSIBLE USES***	Chocolate with fruit Marshmallows Fondant Icing / Icing Velvet cakes Cream	Glazing & Decoration Fondant Icing/ Icing Biscuit Velvet cakes Meringues Macaroons	Icing Velvet cakes Macaroons	Icing Velvet cakes Macaroons

*Taste: variable depending on the product and the amount used.

** Colour: variable depending on the product and the amount used.

*** The declaration statement, quantity limits and possible uses depend on the regulations in force in the country of marketing and/or export and sometimes have no direct link with the natural qualities of the material in question. It is therefore very important to double check these aspects when creating your recipe.

Here, we show you current regulations for Europe.



CREATE YOUR OWN COLORS
MIXING THE PRIMARY HUES
(RED, YELLOW AND BLUE)



100% FRUIT/VEGETAL POWDERS

OUR TIPS

TIP N° 1

To make creations with a harmonious balance of flavors between white chocolate and fruit we recommend adding 5% freeze-dried fruit powder to your covering chocolate.

Please note that the use of fruit powders in milk chocolate, white caramelized chocolate, and fortiori dark chocolate, creates a more subtle color shade than with white chocolate, all the while maintaining the intensity of the flavors.

TIP N° 2

How to use freeze-dried fruit powder in chocolate?

Just add the powder to the tempered chocolate. It does not inhibit tempering and will mix in like any powdered dye or food colouring...

How to use freeze-dried fruit powder in other applications?

Mix the powder with a portion of the powdered sugar from the recipe to facilitate its dispersion in the mix.



045003
Mango powder - 200 g



050226
Passion fruit powder - 200 g
N/A: Japan



045004
Barley grass powder (gluten free)
200 g - N/A: USA



045000
Strawberry powder - 200 g
N/A: USA, Taiwan



045001
Raspberry powder - 200 g
N/A: USA



074338
Hibiscus powder - 200 g - N/A: USA



045002
Blackcurrant powder - 200 g
N/A: USA



060646
Matcha powder - 200 g
N/A: USA



065302
Black cocoa powder - 200 g
N/A: USA

FAT SOLUBLE POWDERS

Procedure: melt the cocoa butter, add some colouring powder and mix with a brush. With this base, you can colour your products. This mixture can be stored: all you need is to melt it before using it again. For your chocolate gun: mix 50% of dark chocolate and 50% of cocoa butter. Add the colouring powder.



COLORING POWDERS

COLOURING
FOODSTUFF

Watersoluble &
Fat-soluble powders



BLUE (spirulina)
 050118 - 50 g
Upon request:
050723 - 200 g
050724 - 1 Kg



GREEN TURF
(carthame, lemon and spirulina) - *N/A: USA, China*
060571 - 50 g
Upon request:
054145 - 200 g
054146 - 1 Kg



LIGHT GREEN
(carthame, lemon and spirulina) - *N/A: USA, China*
060572 - 50 g
Upon request:
054147 - 200 g
054148 - 1 Kg



YELLOW (safflower, lemon) - *N/A: USA, China*
050080 - 50 g
Upon request:
049991 - 200 g
050719 - 1 Kg



ORANGE (carthame, lemon paste and radish, blackcurrant and apple)
N/A: USA, China
060573 - 50 g
Upon request:
053940 - 200 g
054140 - 1 Kg

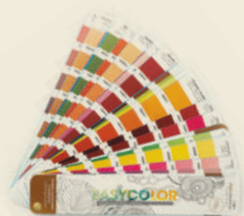

054394
 Colour chart "Easycolor" for colouring foodstuff



PINK* (red beetroot juice)
 050081 - 50 g
Upon request:
050721 - 200 g
050722 - 1 Kg



PURPLE (carrot, hibiscus)
N/A: USA
065301 - 50 g
Upon request:
068114 - 200 g
068847 - 1 Kg



BRIGHT RED (radish, blackcurrant, apple)
 050079 - 50 g
Upon request:
049990 - 200 g
050720 - 1 Kg

NATURAL
COLOURS

Natural fat-soluble powders



NATURAL PINK
(E120) *N/A: China, Japan*
004612 - 25 g
Upon request:
004401 - 200 g
001848 - 1 Kg



NATURAL BLACK
(E153) *N/A: USA, South Korea*
004604 - 25 g
Upon request:
006723 - 200 g
018110 - 1 Kg



NATURAL PURPLE
(E163) *N/A: China*
004658 - 50 g
Upon request:
004415 - 200 g
002178 - 1 Kg



NATURAL GREEN
(E141) *N/A: USA, Canada, Japan, South Korea, Taiwan*
004657 - 50 g
Upon request:
004410 - 200 g
018113 - 1 Kg



NATURAL YELLOW
(E100)
065311 - 25 g
Upon request:
064164 - 200 g
069332 - 1 Kg



NATURAL ORANGE
(E100, E163)
N/A: Singapore
065259 - 25 g
Upon request:
064763 - 200 g
069335 - 1 Kg

SYNTHETIC
COLOURS

Fat-soluble powders



GREEN • (E102, E133)
N/A: UAE, Saudi Arabia, Qatar, Kuwait, Bahrain, Oman
004463 - 25 g
Upon request:
005065 - 200 g
001877 - 1 Kg



ORANGE • (E110)
N/A: UAE, Saudi Arabia, Qatar, Kuwait, Bahrain, Oman
004464 - 25 g
Upon request:
005046 - 200 g
017845 - 1 Kg



RED • (E129) *N/A: UAE, Saudi Arabia, Qatar, Kuwait, Bahrain, Oman*
004462 - 25 g
Upon request:
004214 - 200 g
003018 - 1 Kg



BLUE (E132)
004460 - 25 g
Upon request:
004230 - 200 g
002190 - 1 Kg



YELLOW • (E102)
N/A: UAE, Saudi Arabia, Qatar, Kuwait, Bahrain, Oman
004461 - 25 g
Upon request:
004217 - 200 g
005084 - 1 Kg



WHITE (E171) *N/A: UAE, Saudi Arabia, Qatar, Kuwait, Bahrain, Oman*
004459 - 50 g
Upon request:
004142 - 200 g
001873 - 1 Kg

Free of colouring Worldwide • Azo

*To use of this reference in white chocolate, we recommend the use of a hand blender to obtain a homogeneous result.

WATER SOLUBLE POWDERS

To colour sugar, almond pastes... These colouring can also be used with airbrush.
Process: dissolve in boiling water or alcohol.



COLORING POWDERS

COLOURING
FOODSTUFF

Water-soluble powders



RED (radish, blackcurrant, apple and paprika extract)
 070266 - 50 g
 Upon request:
 071868 - 200 g
 073064 - 1 Kg



PURPLE (carrot, hibiscus)
 N/A: USA
 065301 - 50 g
 Upon request:
 068114 - 200 g
 068847 - 1 Kg



BLUE (spirulina)
 050118 - 50 g
 Upon request:
 050723 - 200 g
 050724 - 1 Kg



GREEN TURF (carthame, lemon and spirulina)
 N/A: USA, China
 060571 - 50 g
 Upon request:
 054145 - 200 g
 054146 - 1 Kg



LIGHT GREEN (carthame, lemon and spirulina)
 N/A: USA, China
 060572 - 50 g
 Upon request:
 054147 - 200 g
 054148 - 1 Kg



ORANGE (paprika extract)
 070269 - 50 g
 Upon request:
 073063 - 200 g
 072435 - 1 Kg



BRIGHT RED (radish, blackcurrant, apple)
 050079 - 50 g
 Upon request:
 049990 - 200 g
 050720 - 1 Kg



YELLOW (safflower, lemon)
 N/A: USA, China
 050080 - 50 g
 Upon request:
 049991 - 200 g
 050719 - 1 Kg



ORANGE (carthame, lemon paste and radish, blackcurrant and apple) - N/A: USA, China
 060573 - 50 g
 Upon request:
 053940 - 200 g
 054140 - 1 Kg



PINK (red beetroot juice)
 050081 - 50 g
 Upon request:
 050721 - 200 g
 050722 - 1 Kg



BROWN (malt extract)
 060576 - 50 g
 Upon request:
 054142 - 200 g
 054141 - 1 Kg

NATURAL
COLOURS

Natural water-soluble powders



NATURAL CARAMEL (E150A)
 004661 - 25 g
 Upon request:
 023662 - 200 g
 045157 - 1 Kg



NATURAL GREEN (E141) N/A: USA, Canada, Japan, South Korea, Taiwan
 004662 - 25 g
 Upon request:
 029552 - 200 g
 049858 - 1 Kg



NATURAL YELLOW (E160A)
 004659 - 25 g
 Upon request:
 023661 - 200 g
 025869 - 1 Kg



NATURAL RED (E120)
 N/A: China, Japan
 004660 - 15 g
 Upon request:
 029551 - 200 g
 018687 - 1 Kg



NEW NATURAL INTENSE RED (E162)
 N/A: Hong Kong
 088215 - 15 g

SYNTHETIC
COLOURS

Water-soluble powders



YELLOW • (E102*) N/A: USA, UAE, Saudi Arabia, Qatar, Kuwait, Bahrain, Oman
 004535 - 15 g
 Upon request:
 023295 - 200 g
 018727 - 1 Kg



BLUE (E133)
 004536 - 15 g
 Upon request:
 023660 - 200 g
 018728 - 1 Kg



RED • (E129*) N/A: USA, UAE, Saudi Arabia, Qatar, Kuwait, Bahrain, Oman
 004534 - 15 g
 Upon request:
 009241 - 200 g
 018725 - 1 Kg



CREATE YOUR OWN COLORS
MIXING THE PRIMARY HUES
(RED, YELLOW AND BLUE)

SHINY COLOURS

This food colouring will make all your products shine and give them an incredible spark.

You have various possibilities:

In powder:

- spread it with your finger
 - sprinkle it on the chocolate
 - sprinkle some powder over a nylon sheet
- Scrub with your finger and place the dipped chocolate bonbons over the sheets.

By diluting with alcohol:
apply it with a brush.



SHINY COLOURS IN POT

COLORING POWDERS



IMPORTANT
These products comply with the Regulations (CE) N° 1333/2008 and the Regulations (UE) N° 231/2012.



SHINY COLOUR "RUBY RED" (E172) N/A: USA, China, Japan, South Korea
025196 - 10 g
Upon request:
029678 - 200 g
029747 - 1 Kg



SHINY COLOUR GLITTER EFFECT "RUBY" (E172) N/A: USA, China, Japan, Qatar, South Korea
004670 - 25 g
Upon request:
004409 - 200 g
018119 - 1 Kg



SHINY COLOUR "RUBY" (E172) N/A: USA, China, Japan, Qatar, South Korea
004485 - 15 g
Upon request:
007527 - 200 g
009144 - 1 Kg



SHINY COLOUR "BRONZE" (E172) N/A: USA, China, Japan, Qatar, South Korea
004483 - 15 g
Upon request:
002247 - 200 g
002276 - 1 Kg



SHINY COLOUR "COPPER" (E172) N/A: USA, China, Japan, Qatar, South Korea
004484 - 15 g
Upon request:
011962 - 200 g
001485 - 1 Kg



SHINY COLOUR GLITTER EFFECT "SILVER" (E171) N/A: China, Japan, UAE, Saudi Arabia, Qatar, Kuwait, Bahrain, Oman, South Korea
004676 - 15 g
Upon request:
001730 - 200 g
003410 - 1 Kg



SHINY COLOUR GLITTER EFFECT "GOLD" (E171, E172) N/A: USA, China, Japan, UAE, Saudi Arabia, Qatar, Kuwait, Bahrain, Oman, South Korea
004669 - 25 g
Upon request:
001782 - 200 g
002741 - 1 Kg



SHINY COLOUR "GOLD" (E171, E172) N/A: USA, China, Japan, UAE, Saudi Arabia, Qatar, Kuwait, Bahrain, Oman, South Korea
004481 - 15 g
Upon request:
001452 - 200 g
001169 - 1 Kg



SHINY COLOUR "SILVER" (E171) N/A: China, Japan, UAE, Saudi Arabia, Qatar, Kuwait, Bahrain, Oman, South Korea
004482 - 15 g
Upon request:
002211 - 200 g
001184 - 1 Kg



SHINY COLOUR "AMETHYST" (E132, E171, E172) N/A: USA, China, Japan, UAE, Saudi Arabia, Qatar, Kuwait, Bahrain, Oman, South Korea
004552 - 15 g
Upon request:
015952 - 200 g
073066 - 1 Kg



SHINY COLOUR "RED" (E129*, E120, E171, E172) N/A: USA, China, Japan, UAE, Saudi Arabia, Qatar, Kuwait, Bahrain, Oman, South Korea
004576 - 15 g •
Upon request:
001196 - 200 g •
018118 - 1 Kg •



SHINY COLOUR "IRIDESCENT PINK" (E171) N/A: China, Japan, UAE, Saudi Arabia, Qatar, Kuwait, Bahrain, Oman, South Korea
004525 - 15 g
Upon request:
010490 - 200 g
005405 - 1 Kg



SHINY COLOUR "IRIDESCENT BLUE" (E171) N/A: China, Japan, UAE, Saudi Arabia, Qatar, Kuwait, Bahrain, Oman, South Korea
004526 - 15 g
Upon request:
022540 - 200 g
018114 - 1 Kg



SHINY COLOUR "IRIDESCENT GOLD" (E171) N/A: China, Japan, UAE, Saudi Arabia, Qatar, Kuwait, Bahrain, Oman, South Korea
004533 - 15 g
Upon request:
022541 - 200 g
018115 - 1 Kg



SHINY COLOUR "EMERALD" (E100, E133, E171, E172) N/A: USA, China, Japan, UAE, Saudi Arabia, Qatar, Kuwait, Bahrain, Oman, South Korea
004479 - 15 g
Upon request:
001767 - 200 g
002175 - 1 Kg



SHINY COLOUR "AMBER" (E120, E171, E172, E100) N/A: USA, China, Japan, UAE, Saudi Arabia, Qatar, Kuwait, Bahrain, Oman, South Korea
004486 - 15 g
Upon request:
004150 - 200 g
008113 - 1 Kg



SHINY COLOUR "SAPPHIRE" (E132, E171) N/A: China, Japan, UAE, Saudi Arabia, Qatar, Kuwait, Bahrain, Oman, South Korea
004480 - 15 g
Upon request:
006848 - 200 g
013303 - 1 Kg

SHINY COLOURS IN SPRAY FORMAT

Add a delightful dash of shiny magic to any and all of your creations. Available in 4 magical shades: add to your desserts, ice creams, chocolate candies, and tier cakes. Follow your creative heart!



040170
1 Shiny powder spray Glitter effect "Silver" - 10 g (E171)
N/A: China, Japan, UAE, Saudi Arabia, Qatar, Kuwait, Bahrain, Oman, South Korea



040172
1 Shiny powder spray Glitter effect "Gold" - 10 g (E171, E172)
N/A: USA, China, Japan, UAE, Saudi Arabia, Qatar, Kuwait, Bahrain, Oman, South Korea



040171
1 Shiny powder spray Glitter effect "Ruby" - 10 g (E172)
N/A: USA, China, Japan, Qatar, South Korea



060568
1 Shiny powder spray Glitter effect "Bronze" - 10 g (E172)
N/A: USA, China, Japan, Qatar, South Korea



100% FRUIT/VEGETAL COCOA BUTTER

We've created a range of fruity cocoa butters especially for you, made from cocoa butter and freeze-dried fruit/plant powders, 100% natural, without colourings; to make a velvet effect using a spray gun or just as they are to naturally add colour to all your creations. Used in velvet on your entremets, these cocoa butters richer in fruit and fiber than a classic cocoa butter (up to 30%) are therefore less brittle, and bring more elasticity for creations with perfect visual and holding. They also bring a touch of fruity taste, a real plus to a classic cocoa butter.

100% FRUIT/ VEGETAL COCOA BUTTERS



 **045008**
Strawberry Cocoa butter
200 g - N/A: Taiwan



 **045009**
Raspberry Cocoa butter
200 g



 **074337**
Hibiscus Cocoa butter
200 g - N/A: USA



 **045011**
Mango Cocoa butter
200 g





 **050227**
Mango Strawberry
Cocoa butter - 200 g
N/A: Taiwan



 **045012**
Barley grass Cocoa
butter - 200 g



 **NEW** **088198**
 Cocoa butter Light cocoa
200 g





 **045013**
 Cocoa butter Brown
cocoa - 200 g



 **045014**
 Cocoa butter Amber
cocoa - 200 g



 **045015**
 Cocoa butter Black
cocoa - 200 g



 **065304**
 White "Flocking" - 200 g
 **065305**
 White "Flocking" - 800 g



 **074172**
 Extra White Cocoa butter
200 g



DISCOVER OUR "COLOUR" CATALOGUE:

Many recipes and application ideas, and a non-exhaustive selection of nuances that you can create with our fruit powders, and fruit/vegetal cocoa butters.



Make your work easier with these ready-to-use coloured cocoa butters which will assure you a perfect colouring. You can use this product in many different ways: with a brush, with a spray (gun, airbrush ...) in order to colour your chocolate, to tint your creams...

COLORED COCOA BUTTERS

COLOURING FOODSTUFF COCOA BUTTERS

Colored cocoa butters - 200 g



 **050076**
Orange (radish, apple, blackcurrant, safflower)
N/A: USA, China

 **050077**
Yellow (safflower, lemon)
N/A: USA, China

 **060580**
Light green (spirulina and carthame)
N/A: USA, China

 **050078**
Green (spirulina, safflower)
N/A: USA, China

 **050073**
 Blue (spirulina)







OTHER PACKAGING OPTIONS ARE AVAILABLE UPON REQUEST

CONTACT-US!



 **065303**
Purple (carrot, hibiscus)
N/A: USA

 **050074**
 Red (radish, apple, blackcurrant)

 **050075**
 Pink (red beetroot juice)

 **NEW 088199**
Caramel color (safflower, lemon and cocoa) 200 g
N/A: USA, China

 **054394**
Colour chart "Easycolor" for colouring foodstuff

NATURAL COCOA BUTTERS

Colored cocoa butters - 200 g



004611
Black (E153)
N/A: USA, China, South Korea

004656
Green (E141)
N/A: USA, Canada, Japan, South Korea, Taiwan

004609
Red (E120)
N/A: China, Japan

004655
Purple (E163)
N/A: China

065295
Orange color (E100, E163) N/A: China, Singapore

 **065312**
Egg yolk color (E100)

 Free of colouring  Worldwide • Azo





CREATE YOUR OWN COLORS
MIXING THE PRIMARY HUES
(RED, YELLOW AND BLUE)

CLASSIC
COCOA
BUTTERS

Colored cocoa butters - 200 g



004457
Pistachio green color •
(E133) N/A: UAE, Saudi
Arabia, Qatar, Kuwait, Bahrain,
Oman



004456
Strawberry red color •
(E129) N/A: UAE, Saudi
Arabia, Qatar, Kuwait, Bahrain,
Oman



004572
Black color (E172)
N/A: USA, China, Japan,
South Korea



004458
Orange color • (E110*)
N/A: UAE, Saudi Arabia,
Kuwait, Qatar, Bahrain, Oman



004470
Raspberry red color •
(E122*) N/A: USA, Canada,
Japan, UAE, Saudi Arabia,
Qatar, Kuwait, Bahrain, Oman,
South Korea, Taiwan,



004454
Blueberry blue color
(E132)



004469
Egg yolk color • (E102*)
N/A: UAE, Saudi Arabia,
Qatar, Kuwait, Bahrain, Oman



004455
Lemon yellow color •
(E104*) N/A: USA, Canada,
China, Japan, UAE, Saudi
Arabia, Qatar, Kuwait, Barhein,
Oman, South Korea, Taiwan



004627
Purple (E120, E133,
E171) N/A: China, Japan,
UAE, Saudi Arabia, Qatar,
Kuwait, Bahrain, Oman



004453
White (E171)
N/A: UAE, Saudi Arabia,
Qatar, Kuwait, Bahrain, Oman



OTHER PACKAGING OPTIONS ARE AVAILABLE UPON REQUEST
CONTACT-US!

SHINY COCOA
BUTTERS

Colored cocoa butters - 200 g



004614
Shiny gold (E171, E172)
N/A: USA, China, Japan,
South Korea, UAE, Saudi
Arabia, Qatar, Kuwait, Bahrain,
Oman



004616
Shiny bronze (E172)
N/A: USA, China, Japan,
Qatar, South Korea



004600
Shiny ruby (E172)
N/A: USA, China, Japan,
Qatar, South Korea



004601
Shiny copper (E172)
N/A: USA, China, Japan,
Qatar, South Korea



004566
Iridescent pink • (E171,
E124*) N/A: USA, Canada,
China, Japan, UAE, Saudi Arabia,
Qatar, Kuwait, Barhein, Oman,
South Korea



004615
Shiny silver (E171)
N/A: China, Japan, UAE,
Saudi Arabia, Qatar, Kuwait,
Bahrain, Oman, South Korea

Free of colouring Worldwide • Azo

SHINY

(045647 - Stars Crystallized +
060554 - White hairs + 074340
Velvet spray "White " + 087014
Entremets moulds "Rond plat arrondi")



VELVET SPRAYS

These sprays make it possible to give a **velvet effect** on your frozen desserts or entremets:
We developed an exclusive new formula: no need to be put in drying oven, our new sprays can be **used at ambient temperature**.
 Let your creativity run wild: underline the "relief" of your dessert, draw using a stencil key set... **You are an artist!**

METHOD OF USE:

Keep the product at room temperature (20-25°C/ 68-77°F) for at least 2 hours before use. Shake well before use.
 Spray an even layer of product on a cold surface from a distance of 20-25 cm.
 After use, turn the spray can upside down and spray for a few seconds to clean the dispenser. Store at room temperature*

*If the product has been stored at a temperature <20°C/ 68°F, place in a bain-marie or oven (35°C/95°F) for around 20 minutes to liquefy the product before use.



 **074339**
 Velvet spray "Dark
 chocolate" - 500 ml
 N/A: China, UAE, Saudi
 Arabia, Qatar, Kuwait,
 Bahrain, Oman

 **074340**
 Velvet spray "White"
 500 ml
 N/A: China, UAE, Saudi
 Arabia, Qatar, Kuwait,
 Bahrain, Oman

 **074345**
 Velvet spray "Yellow"
 500 ml
 N/A: USA, China, UAE,
 Saudi Arabia, Qatar, Kuwait,
 Bahrain, Oman

 **074344**
 Velvet spray "Green"
 500 ml
 N/A: USA, China, UAE,
 Saudi Arabia, Qatar, Kuwait,
 Bahrain, Oman

 **074343**
 Velvet spray "Orange"
 500 ml
 N/A: USA, China, UAE,
 Saudi Arabia, Qatar, Kuwait,
 Bahrain, Oman

 **074342**
 Velvet spray "Pink"
 500 ml
 N/A: China, UAE, Saudi
 Arabia, Qatar, Kuwait,
 Bahrain, Oman

 **074341**
 Velvet spray "Red"
 500 ml
 N/A: China, UAE, Saudi
 Arabia, Qatar, Kuwait,
 Bahrain, Oman





THE TWO PRODUCTS BELOW CAN BE USED FOR GLAZING, FINISHING AND PROTECTING CHOCOLATE COATED SUGAR CONFECTIONERY.

VARNISH FOR MOULDING & COATING



070268 is a glazing solution based on gum arabic which is used to gloss the sugar-coated confectionery and should be applied first. 061076 is a shellac based glazing solution that provides a protective layer against moisture and air and should be applied last.

- The surface of the chocolate coated centers must be completely solidified before applying the finishing solutions

- The air blower for drying the dragees following application of the finishing solutions must comply with the following characteristics

- maximum 45-50% relative humidity
- 10-12°C for white chocolate, 12-14°C for milk chocolate and 16-18°C for dark chocolate



061076

Varnish pearly for chocolate moulding - 200 g
N/A: China, Japan, UAE, Saudi Arabia, Qatar, Kuwait, Bahrain, Oman

070268

Coating solution made of gum arabic - 1 Kg
This product must be shaken sufficiently before use because it tends to phase out.
N/A: UAE, Saudi Arabia, Qatar, Kuwait, Bahrain, Oman

A TYPICAL EXAMPLE WITH CHOCOLATE COVERED HAZELNUTS:

	PRODUCT USED	QUANTITY (mL/100Kg)	MIXING WITHOUT AIR BLOWER	DRYING WITH AIR BLOWER
1ST LAYER	070268	250 mL	1-2 min	7-10 min
2ND LAYER		150 mL		
3RD LAYER		100 mL		
LAST LAYER	061076	130-170 mL		5 min

These solutions can be applied simply by pouring the recommended amount using a measuring cup or syringe. When using a spray system, it is vital to use two separate systems for the two products as these solutions are not compatible. After these different layers have been applied, the dragees must be set aside for at least 2 hours to finalise the drying process before packing. We recommend storing them in an environment with the same atmospheric conditions as those used for glazing.



DÉCOR À MODELER

Discover our modelling décor recipe! Its new, more malleable texture allows for easy modelling, and its newly refined ingredients bring out its great white chocolate flavour. Mouldable like marzipan, you can cover your desserts and create fabulous hand-made decorations or use a pastry cutter. To be used alone or with the support of a silicone mould, you can no longer do without this magical paste!

DÉCOR À MODELER



SEE INSTRUCTIONS ON OUR WEBSITE



025197
Décor à modeler "White chocolate" - 500 g



025198
Décor à modeler "Dark chocolate" - 500 g



025205
Décor à modeler "Black" - 500 g
N/A: USA, China, South Korea



025200
Décor à modeler "Red" - 500 g - N/A: China, Japan



025201
Décor à modeler "Green" - 500 g



025202
Décor à modeler "Yellow" - 500 g



060969
Décor à modeler "Orange" - 500 g
N/A: China, Japan



025199
Décor à modeler "White" - 500 g - N/A: UAE, Saudi Arabia, Qatar, Kuwait, Bahrain, Oman



060968
Décor à modeler "Pink" - 500 g
N/A: China, Japan

Free of colouring Worldwide • Azo



PIPETTES & TUBES TO FILL

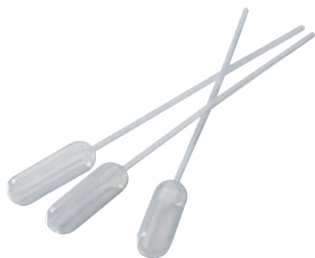

004558
100 Pipettes 15,5 x 1,3 cm



004575
30 Tubes to fill - 30 ml



004640
1 Clamp for tube

004664
30 Tubes to fill - 15 ml

Looking for something out of the ordinary for your desserts? Something to impress your guests? Your customers will delight in using the pipettes to inject coulis into their dessert and marvel at DIY decoration with their own tube. Coulis, ganache... let your imagination run wild!

PASTRY-MAKING USTENCILS



004550
Spray topping - 500 ml

For all your products which require a shiny appearance as well as a protection against oxidation. This spray with a subtil fruity taste could be used to cover: your "petits fours", your fruits, your Joconde biscuit, your tarts by giving them a thin and regular glaze. *N/A: USA, China, Japan, UAE, Saudi Arabia, Qatar, Kuwait, Bahrain, Oman*



004499
Unmold spray - 500 ml

Spray a thin layer on your moulds before filling to make turning out a breeze. *N/A: USA, China, UAE, Saudi Arabia, Qatar, Kuwait, Bahrain, Oman*



004570
Air blower - Cooler - 335 ml
The right way up, you can use it as a cooler. Upside down, you can use it as an air blower. This product is ideal to work on your artistic creations during competitions...
N/A: USA, China

A MUST-HAVE!



010384
Sublimasse nature - 900 g

In order to obtain an even more fabulous result, we have created a compound, which once hydrated, will be applied over the baking sheet prior to your biscuit. This product prevents the appearance of air bubbles on the surface of your biscuit and also allows your biscuit to be more airy.
N/A: USA, Canada, Japan, South Korea, UAE, Saudi Arabia, Qatar, Kuwait, Bahrain, Oman, Taiwan, Singapore



004472
Edible glue - 160 g

This glue is used to stick chocolate figures on the presentation carton.
N/A: USA, UAE, Saudi Arabia, Qatar, Kuwait, Bahrain, Oman



004492
Pot of 400 ml

Ideal to store all your liquid recipes (colouring, icing, etc...). A hygienic bottle, ideal for microwaves, to dose without a drop.

No more wasted icing, effort, time or energy and a streamlined process for icing your cakes thanks to this icing turntable developed by Arnaud Larher. It allows icing to be recovered via a channel directly into the pail without moving the cake or the turntable.



ARNAUD
Larher

004710
Icing turntable



007208
5 Knives



087076
10 Sparkling candles - *N/A: Hong Kong*



007196
Silicone baking net - size: 40 x 60 cm

Free of colouring • Worldwide • Azo



NEUTRAL SHEETS

Those rigid sheets will allow you to make your chocolates "shine".

These supple sheets will allow you to "shine" your chocolates and to spread your ganache before cutting them up with your guitar.

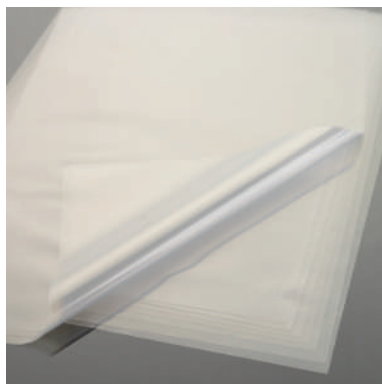
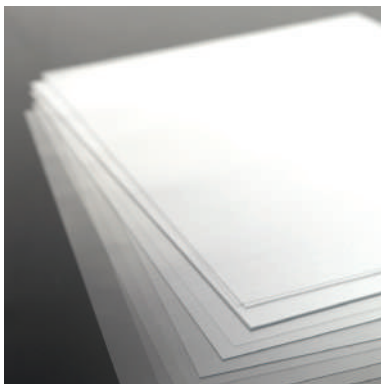

005008
25 Rhodoïde sheets size 40 x 60 cm

005009
500 Guitare sheets size 40 x 60 cm

005012
100 Guitar sheets bundled 38 x 38 cm

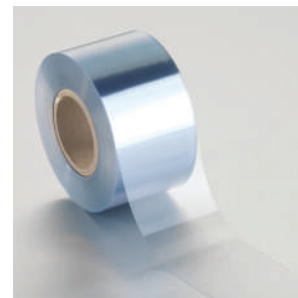
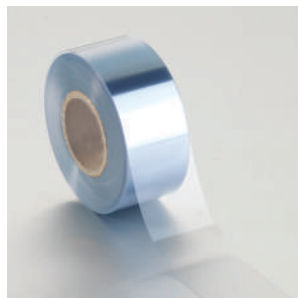
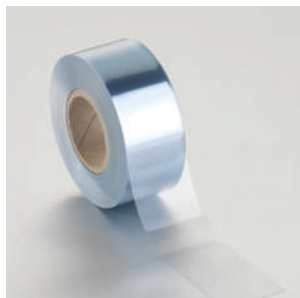
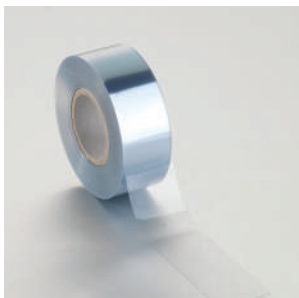

010920
1 Roll neutral 4 cm x 50 m

010922
1 Roll neutral 4,5 cm x 50 m

010921
1 Roll neutral 5 cm x 50 m

010923
1 Roll neutral 6 cm x 50 m

This baking paper will allow you to serve sweet or savoury paper-wrapped dishes which will please your clients by their presentation. In fact, this extremely transparent paper goes directly from the oven to the serving plate. It will astonish your guests and will make them appreciate even more, this way of cooking and presentation.

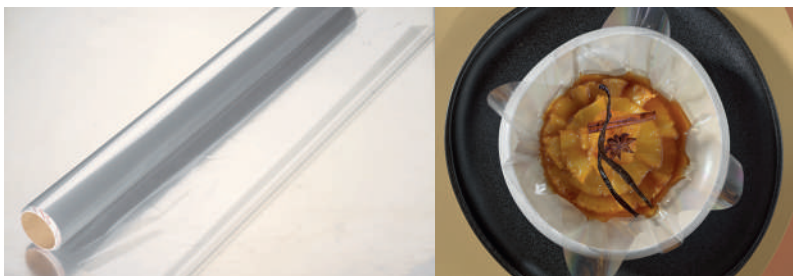

004561
1 Roll 50 cm x 25 m

036133
5 White rigid plates 74 x 54 cm - Th. 2 mm

SUMMARY OF DECORATIONS | FINISHED DECORATIONS

“MERINGUÉS“ DECORATIONS

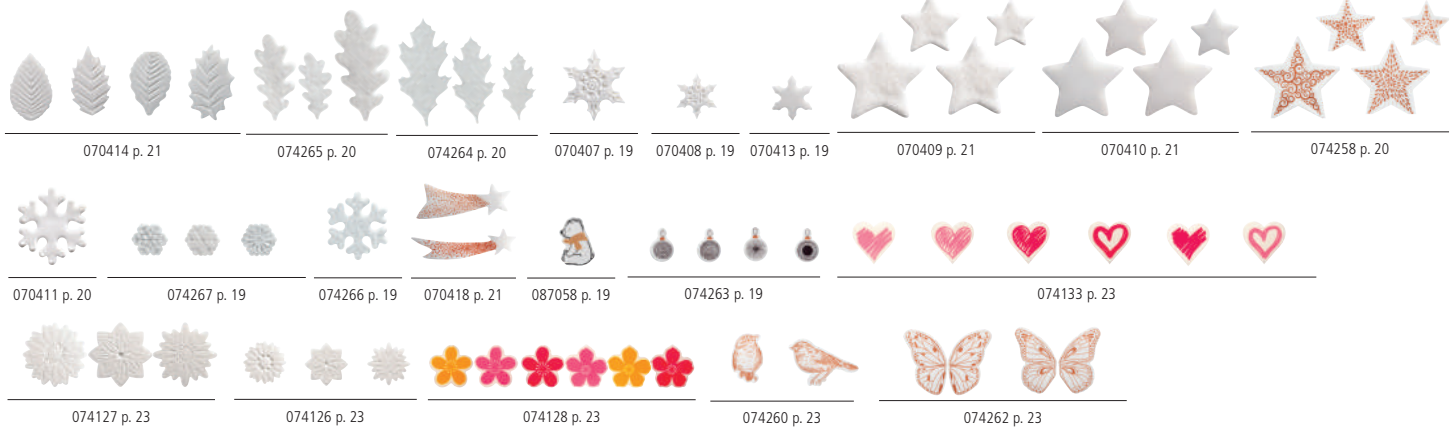

OPALINES & CRYSTAL DECORATIONS

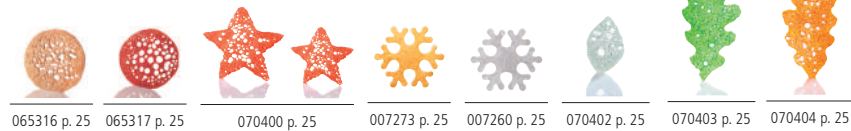

HAPPY HALLOWEEN



HAPPY THANKSGIVING

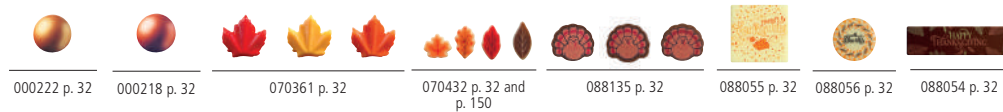

3D CHRISTMAS DECORATIONS

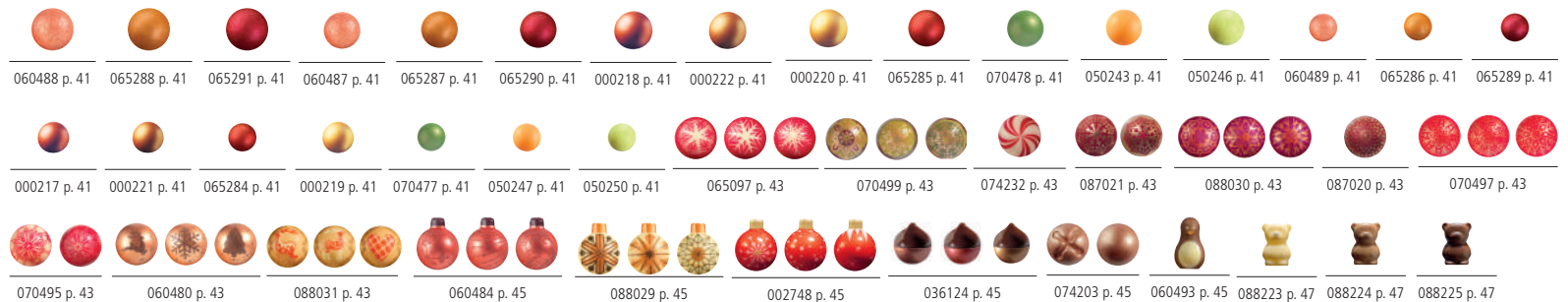



CHRISTMAS DECORATIONS

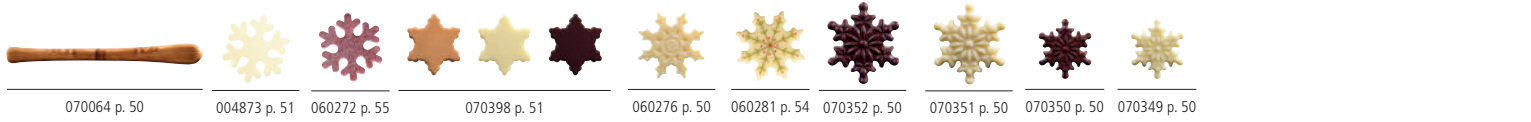
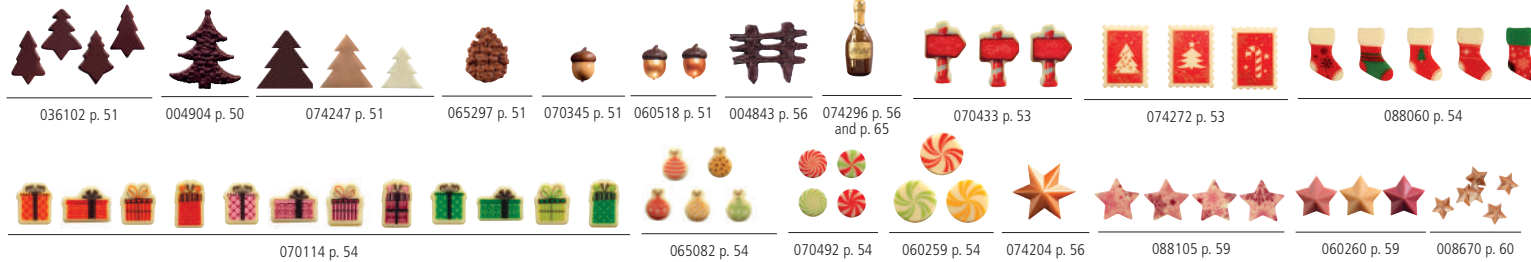

CHOCOLATE PIECES



CHOCOLATE PIECES

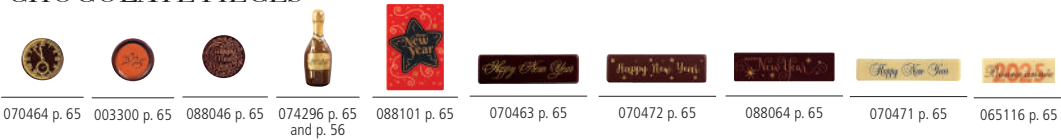

ENDS OF YULE LOG

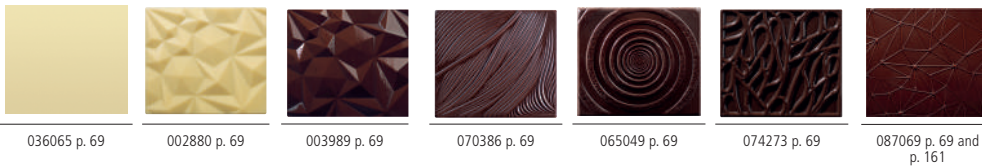

SMALL ENDS OF YULE LOG



ECLAIR CHOCOLATE TOPPINGS



EMBOSSED PIECES



“NATURE“ DECORATIONS



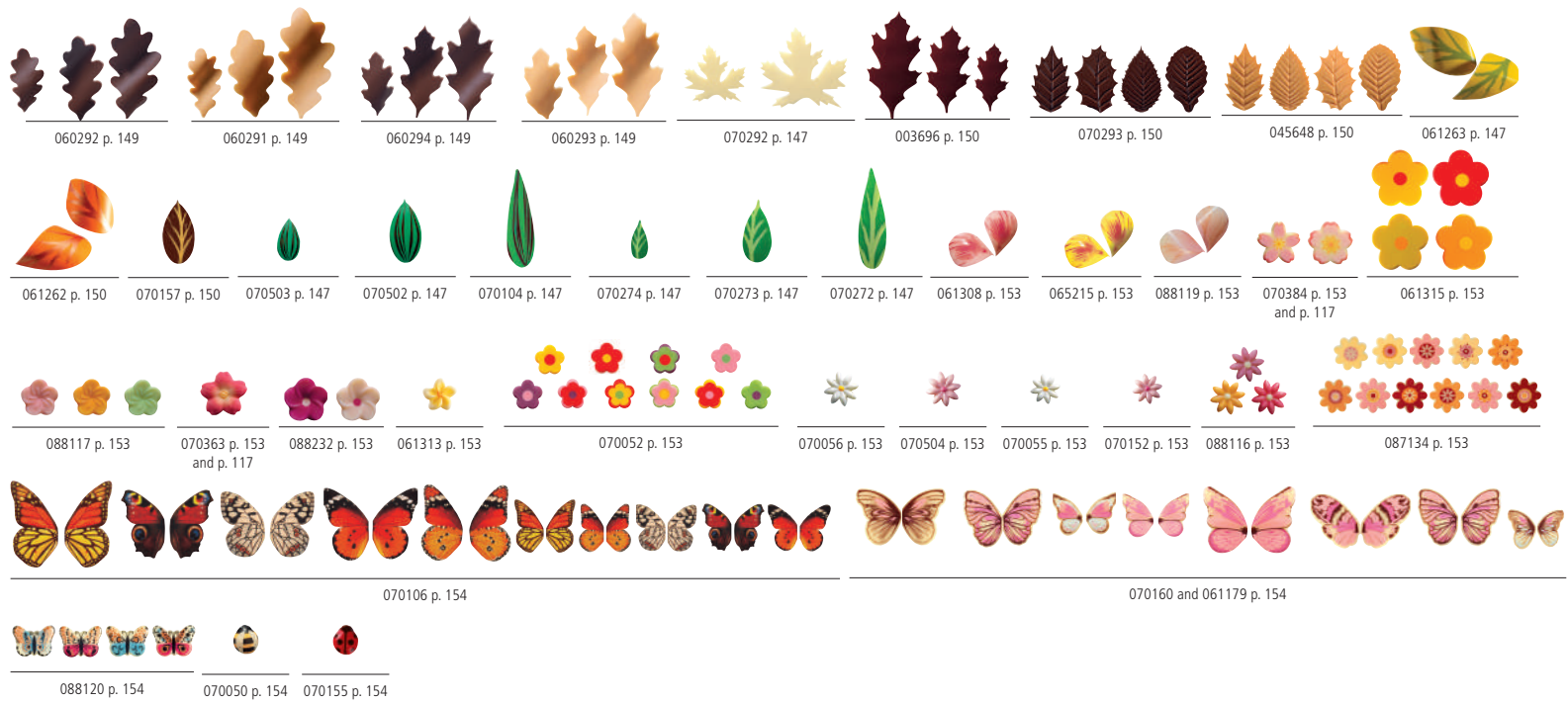

MIDDLE EAST COLLECTION



EXTRA THIN DECORATIONS

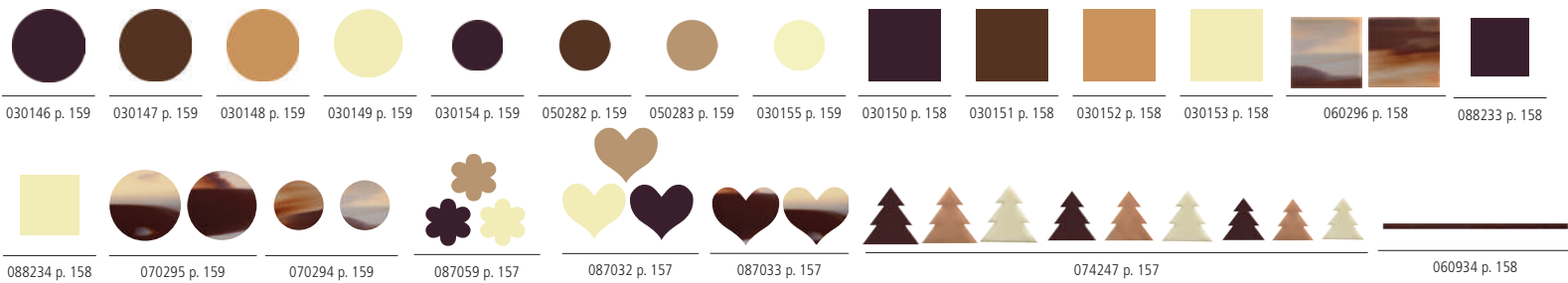

TIMELESS DECORATIONS

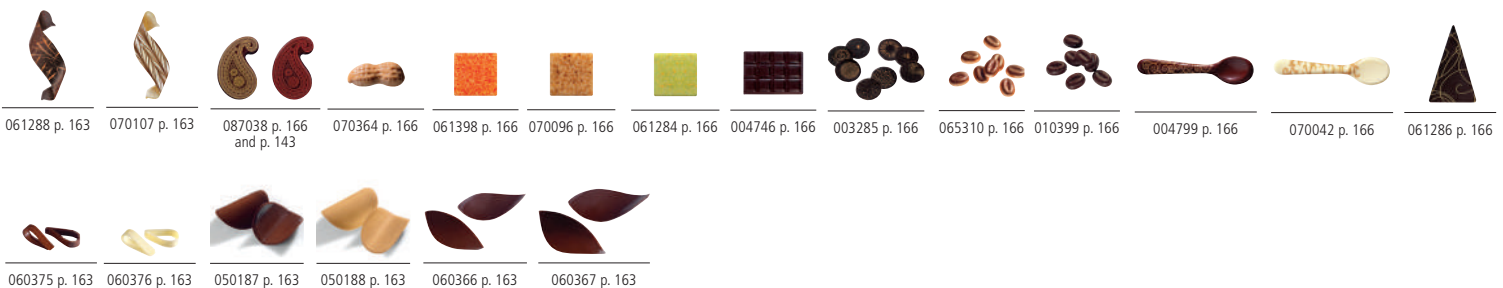

STICKS



MIXED CIRCLES



EXTRA THIN STRUCTURED DECORATIONS



BIRTHDAY DECORATIONS



MARSHMALLOW DECORATIONS



ACCESSORIES FOR CHARACTERS

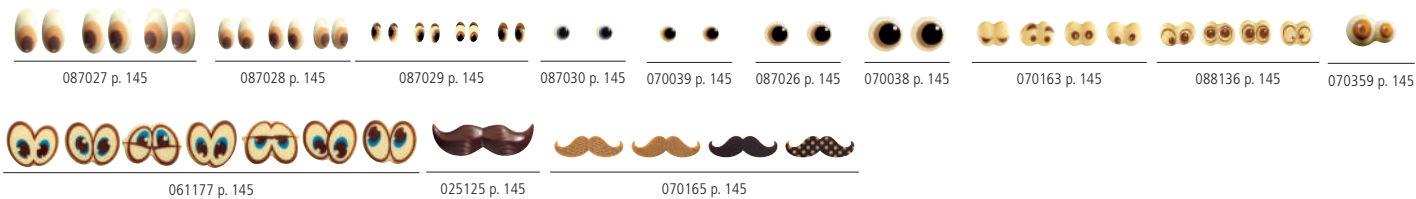

VALENTINE'S DAY



CELEBRATION DAYS PIECES



ASIAN COLLECTION



EASTER



BLISTERS TO FILL

The references below refer to blisters.
All you have to do is add your own chocolate to the different moulds and voila!
You get magnificent decorations. Using these blisters couldn't be easier.

Before using: Your room and your work surface must be tempered to +22°C, to optimize the removal and demoulding of your decorations.
Printed blisters: Fill the blisters with your chocolate (be careful to keep the temperature of the chocolate at its optimum level throughout the filling process). Lightly vibrate/shake the blister pack for 15 to 20 seconds. Then land the chocolate slightly crystallise (1 minute) without moving the blister- pack. Refrigerate at 4°C for 30 minutes to 2 hours depending on the size and volume of the products. Unmould by pushing gently from underneath

Neutral blisters: Fill the blisters with your chocolate. Lightly vibrate/shake the blister pack to drive out air bubbles. Refrigerate at 4°C for 30 minutes to 1 hour depending on the size of the chocolate pieces. Unmould. Neutral blisters are reusable: you can clean them with cotton wipes. Please note that the gloss effect will decrease gradually with use.



STENCILS



025120 p. 193



010714 p. 51 and p. 193



060326 p. 193



010721 p. 193



010745 p. 193

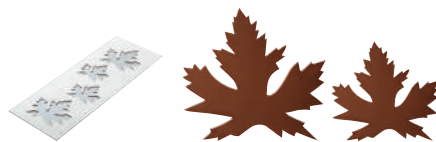

010715 p. 193

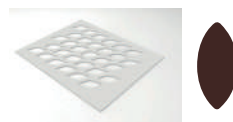

010738 p. 194



010700 p. 195



030068 p. 195

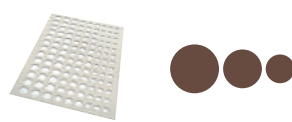

010706 p. 194



040021 p. 194



010691 p. 194



010692 p. 194



010704 p. 194



010690 p. 194



019153 p. 195

SUMMARY OF KITS

CHOCOLATE KITS



004433 p. 79



070017 p. 79



004431 p. 79



065243 p. 79

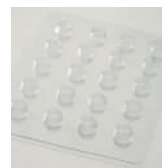

009885 p. 79

PRINTED MOULDS



088255 p. 80



060596 p. 81



065242 p. 81



070437 p. 81



087169 p. 81



065274 p. 81



070438 p. 81



060597 p. 82



087164 p. 111



074196 p. 127



088090 p. 127



088091 p. 127



074145 p. 127



061227 p. 127



074002 p. 127

BLISTER PUZZLES



074248 p. 89



074249 p. 89



070237 p. 89



087171 p. 89



087172 p. 89



088066 p. 89



004428 p. 89

BLISTERS LOLLIPOPS



087034 p. 211



061248 p. 211



070176 p. 126



061387 p. 211



070014 p. 211



087066 p. 211



060206 p. 212



070389 p. 212



074166 p. 212



070238 p. 111 and p. 212



070390 p. 29



040159 p. 212



074165 p. 212



074290 p. 90

070018 p. 91

087051 p. 91

070022 p. 91



070186 p. 91

074202 p. 91

061247 p. 91

088067 p. 90

004560 p. 91, p.211

004478 p. 91

002138 p. 91, p. 211

TRANSFER SHEETS & MOULDS FOR KITS



010144 p. 95

074251 p. 95

088072 p. 95

009961 p. 95

004429 p. 95

004432 p. 95



070324 p. 95

070325 p. 95

088073 p. 95

025191 p. 93, p. 111 and p. 221

087180 p. 111

088068 p. 93

087003 p. 93

070188 p. 221



009884 p. 93

070421 p. 93

070326 p. 93

088071 p. 93

050117 p. 221

061123 p. 221



088237 p. 29

088186 p. 29

045558 p. 94

088069 p. 94

088070 p. 94

087004 p. 94

070428 p. 221

070583 p. 221



070436 p. 221

088185 p. 220

NEUTRAL MOULDS FOR TABLETTES



045564

12 Moulds "Avent" for 12 pieces 19,6 x 16,5 cm
Th. 0,7 cm - Weight: ± 220 g - P. 85



088247

12 Moulds "P'tit biscuit" for 12 pieces 11,6 x 14 cm
Th. 1,8 cm - Weight: ± 100 g - P. 85



074314

12 Moulds "Tablette horloge" for 12 pieces
ø 15,5 cm - Th. 1cm - Weight: ± 130 g - P. 85



087065

12 Moulds "Couronne de l'avent" for 12 pieces
18 x 19 cm - Th. 1,5 cm - Weight: ± 180 g - P. 85

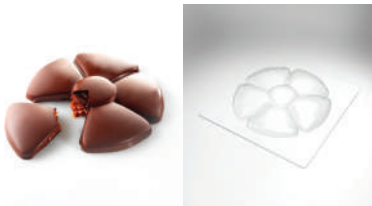

074076

12 Moulds "Fleur" for 12 pieces ø 15 cm
Th. 1,6 cm - Weight: ± 210 g - P. 219



040150

2 Moulds "Tablette Lapins" for 8 pieces
15 x 14 cm - Th. 0,7 cm - Weight: ± 100 g - P. 131



025192

2 Moulds "Cœurs" for 8 pieces
15,5 x 6,2 cm - Weight: ± 70 g - P. 111 and P. 219



070422

10 Moulds "French Kiss" 7,8 x 12,2 cm - 6,8 x 10,2 cm
Th. 2 cm - Weight: ± 180 g - P. 111 and P. 219



009960

2 Moulds "Zodiaque" 12 designs for 12 pieces
12 x 12 cm - Weight: ± 65 g - P. 219



004429

Packing boxes for square
cards - P. 219

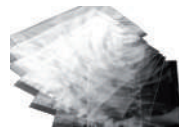

004432

100 bags for square cards
P. 219

MARSHMALLOW MOULDS



088242

10 Marshmallow moulds "Fantôme" for
120 pieces 5,7 x 7 cm - Th. 2 cm - P. 209



088243

10 Marshmallow moulds "Ourson" for
80 pieces 5 x 8 cm - Th. 2,2 cm - P. 209



088244

10 Marshmallow moulds "Lapinou" for
80 pieces 4,3 x 8,5 cm - Th. 2,4 cm - P. 209

ADVENT CALENDARS



087008 p. 34



070399 p. 34



074334 p. 34



088057 p. 34



074330 p. 37



088058 p. 37

NEUTRAL MOULDS FOR KITS



070423
9 Moulds coffin "Six pieds sous terre" Bottom:
7,9 x 14,6 cm - Th. 3 cm - Cover: 7,9 x 14,6 cm
Th. 1,37 cm - Skeleton: 6,5 x 13,2 cm - Th. 0,8 cm
P. 29



074321
14 Moulds "Grimoire Halloween" for 4 pieces
10 x 13 cm - Th. 4 cm - Weight: ± 160 g - P. 29



088236
12 Moulds "Chauve-souris" for 6 pieces
10 x 14,2 cm - Th. 4,65 cm - Weight: ± 65 g
P. 29



060208
10 Moulds "Hiboux" for 5 pieces
10,7 x 12 cm - Th. 9,7 cm - Weight: ± 120 g - P. 214



060209
10 Moulds "Ours frileux" for 5 pieces
9 x 15 cm - Th. 6 cm - Weight: ± 90 g - P. 87



065089
10 Moulds "Renard sur son 31" pour 5 pieces
11 x 12 cm - Th. 7,65 cm - Weight: ± 120 g - P. 214



070427
8 Moulds Écureuil "Scrat" for 4 pieces
13,4 x 12,5 cm - Th. 7,5 cm - Weight: ± 100 g - P. 214



070424
12 Moulds "Teddy bear" for 4 pieces 8,6 x 13,4 cm
2,8 x 6,4 cm - 2,4 x 5 cm - Th. 6,9 cm
Weight: ± 100 g - P. 218



087062
10 Moulds "Renard" for 5 pieces
8 x 13 cm - Th. 8 cm - Weight: ± 90 g - P. 214



060212
9 Moulds "Mon Beau Sapin" for 3 pieces
ø 14 cm, ø 11 cm, ø 8 cm, ø 6 cm, ø 4 cm
Weight: ± 100 g - P. 82



070429
10 Moulds "Sapin Poché" for 5 pieces 11,6 x 15 cm
Th. 11,8 cm - Weight: ± 100 g - P. 82

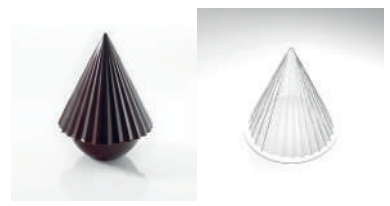

074317
12 Moulds "Sapin Cône strié" for 12 pieces
ø 11 cm - H. 12 cm - Weight: ± 55 g - P. 82



088238
8 Moulds "Sapin vrille" for 4 pieces - 9,6 x 15 cm
Th. 9,5 cm - Weight: ± 70 g - P. 83



009842
6 Moulds "Traîneau" for 2 pieces 21 x 10,5 cm
H. 13 cm - Weight: ± 300 g - P. 86



070581
9 Moulds "Père Noël et sa hotte" for 4 pieces
7,7 x 15 cm - Th. 5,7 cm - Weight: ± 100 g - P. 87



074316
12 Moulds "Père Noël Slave" for 6 pieces
12,7 x 13 cm - Th. 7,5 cm - Weight: ± 120 g - P. 87



010208
8 Moulds "Père Noël bonnet" for 4 pieces
6 x 5,8 cm - H. 14 cm - Weight: ± 45 g - P. 87



074311
12 Moulds "Casse Noisette" for 6 pieces
6 x 17 cm - Th. 5,2 cm - Weight: ± 70 g - P. 87



074318
15 Moulds "Boules de Noël" for 15 pieces - 5 designs
5 x 5,8 cm - Th. 2,5 cm - Weight: ± 20 g - P. 87

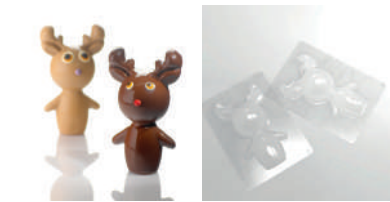

045563
20 Moulds "Renne" for 10 pieces 9 x 15 cm
Weight: ± 105 g - P. 82



074077
12 Moulds "Œuf cabosse" for 6 pieces
10,6 x 17 cm - Th. 10,6 cm - Weight: ± 120 g - P. 130



074087
16 Moulds "Œuf visage Risette" for 8 pieces 4 designs 8,6 x 13,3 cm - Th. 9,6 cm
Weight: ± 80 g - P. 131

074124
20 Moulds half-eggs for 10 pieces 8,7 x 13,4 cm - Weight: ± 100 g

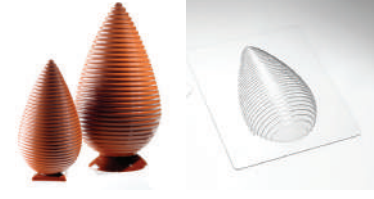

074091
12 Moulds "Œuf Larme strié" for 6 pieces
8,5 x 15 cm - Th. 8,5 cm - Weight: ± 120 g - P. 128

074081
12 Moulds "Œuf Larme strié" for 6 pieces
11,5 x 19 cm - Th. 11,5 cm - Weight: ± 150 g - P. 128



074090

12 Moulds "Œuf Fleurs" for 6 pieces 10 x 15 cm
Th. 10 cm - Weight: ± 130 g - P. 128



010314

12 Moulds "Œufs Diamant" for 6 pieces 3 designs
Large: 21,5 x 14 cm - Weight: ± 280 g - Medium:
14,2 x 9,4 cm - Weight: ± 130 g - Small: 12,2 x 8 cm
Weight: ± 90 g - P. 128



074092

12 Moulds "Œuf vague" for 6 pieces 2 designs
8,2 x 13 cm - 9,6 x 15 cm - Th. 8,2 - 9,6 cm
Weight: ± 85 g - 120 g - P. 128

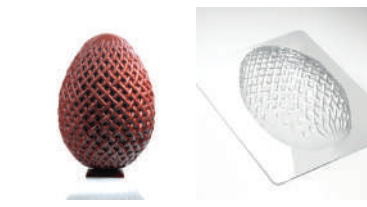

074086

12 Moulds "Œuf tissé" for 6 pieces 10 x 15 cm
Th. 10 cm - Weight: ± 130 g - P. 128



088239

12 Moulds "Œufs textures" for 6 pieces 2 designs
9,8 x 15 cm - Th. 9,8 cm Weight: ± 130 g - P. 129



074089

12 Moulds "Œuf Mandala" for 6 pieces 10 x 15 cm
Th. 10 cm - Weight: ± 130 g - P. 128



074096

12 Moulds "Poule et Coq" for 6 pieces - 2 designs
12 x 14,3 cm, 11 x 18,5 cm - Th. 8 cm - 9 cm
Weight: ± 65 g - 80 g - P. 137



074100

24 Moulds "Poulettes" for 12 pieces 3 designs
9,4 x 9,9 cm, 8,5 x 10 cm, 10,5 x 6,5 cm
Th. 6,4 cm - Weight: ± 30 g - P. 137



088251

24 Moulds "Joyeux trio de poulettes" for 12 pieces
3 designs - 6,65 x 7,35 cm - 6 x 8,55 cm
6,2 x 8,7 cm - Th. ± 5 cm - Weight: ± 30 g
P. 137



088241

16 Moulds poulette "La comtesse" for 8 pieces
12,4 x 14 cm - Th. 10 cm - Weight: ± 115 g
P. 136

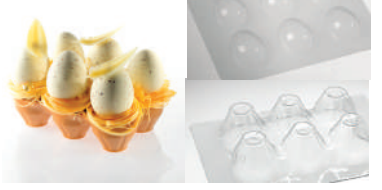

074123

10 Moulds "Boîte à œufs" for 10 pieces
15,5 x 10,5 cm - Th. 4 cm - Weight: ± 90 g - P. 137



074088

12 Moulds "Les Binoclrards" for 6 pieces - 2 designs
9,8 x 14 cm, 9,8 x 10,9 cm - Th. 10,3 cm - 9,6 cm
Weight: ± 150 g - P. 137



074305

20 Moulds "Mouton pelote" for 10 pieces
7,7 x 8,8 cm - Th. 7,2 cm - Weight: ± 45 g - P. 137



074121

16 Moulds "Bord de mer" for 4 pieces 5 designs
Palms: 10 x 8 cm Th: 2,4 cm - Tubas: 4,5 x 10 cm
Th: 0,7 cm - Bottles: 11 x 2,6 cm Th: 1,3 cm - Big
masks: 5,5 x 3,1 cm - Th: 1 cm - Small masks:
4,2 x 2,2 cm Th: 1 cm - P. 138



074079

12 Moulds "Coquillage conque" for
6 pieces 11,3 x 15 cm - Th. 10 cm
Weight: ± 120 g - P. 139



074104

12 Moulds "Hippocampe" for 6 pieces 9,8 x 13 cm
Th. 6 cm - Weight: ± 85 g - P. 138



074078
12 Moulds "Baleine" for 6 pieces 17,5 x 8,7 cm
Th. 7,2 cm - Weight: ± 120 g - P. 138



074084
16 Moulds "Poussin matelot" for 8 pieces 4 designs
9,4 x 13 cm, 10,2 x 13 cm, 9,8 x 13 cm - Th. 7,6 cm
7,5 cm - 8,5 cm - 8 cm - Weight: ± 120 g - P. 138



074120
16 Moulds "Boîte à sardines" for 8 pieces
11,5 x 7 cm - Th. 3,3 cm - Weight: ± 70 g - P. 138



074323
12 Moulds "Friture sardine" for 216 pieces
3 designs 9 x 2,2 cm - H. 0,7 cm - Weight: ± 7 g
P. 131



074327
12 Moulds "Friture Lapinou" for 432 pieces
9 designs - Th. 1 cm - Weight: ± 6 g - P. 131



088240
12 Moulds "Lapin dodu" for 6 pieces 7 x 12 cm
Th. 8,1 cm - Weight: ± 70 g - P. 134



074082
12 Moulds "Œuf Oreille" for 6 pieces 9,5 x 19,5 cm
Th. 9,5 cm - Weight: ± 160 g - P. 135



074083
12 Moulds "Œuf Lapin" for 6 pieces 9,3 x 15 cm
Th. 9,5 cm - Weight: ± 130 g - P. 135



074098
12 Moulds "Lapin Boule" for 6 pieces 11 x 11 cm
Th. 9,2 cm - Weight: ± 100 g - P. 132



074108
12 Moulds "Teddy lapin" for 4 pieces - Body:
8,1 x 15 cm - Arm: 1,9 x 4,2 cm - Foot: 2,4 x 4,9 cm
Th. 7 cm - Weight: ± 100 g - P. 132



040153
8 Moulds lapin "Facettes" for 4 pieces
13 x 11,5 cm - Th. 7 cm - Weight: ± 115 g
P. 132



074112
20 Moulds "Petits Rabbits" for 10 pieces 8 x 8 cm
Th. 5 cm - Weight: ± 30 g - P. 132

074095
12 Moulds "Rabbits" for 6 pieces 12,5 x 12,5 cm
Th. 9 cm - Weight: ± 55 g - P. 132



074094
12 Moulds "Lapin Moustache" for 6 pieces
8,8 x 15 cm - Th. 5,6 cm - Weight: ± 90 g - P. 132



074093
12 Moulds "Lapin Peluche" for 6 pieces
10,3 x 14,7 cm - Th. 7,2 cm - Weight: ± 110 g
P. 132



074309
12 Moulds "Lapin Astronaute" for 6 pieces
9,2 x 15 cm - Th. 7,1 cm - Weight: ± 80 g - P. 133



074312
12 Moulds "Mini lapin Astronaute" for 12 pieces
5,1 x 6,7 cm - Th. 3,1 cm - Weight: ± 15 g - P. 133

074313
12 Moulds "Mini Astronaute" for 12 pieces
5,1 x 5,3 cm - Th. 3,1 cm - Weight: ± 15 g - P. 133



074103
12 Moulds "Licorne" for 6 pieces 11,4 x 12,5 cm
Th. 7,5 cm - Weight: ± 85 g - P. 214



088250
8 Moulds "Carotte" for 8 pieces 4,2 x 15 cm
Th. 4,2 cm Weight: ± 55 g - P. 135



074307
12 Moulds "Fusée" for 6 pieces 8,7 x 14,9 cm
Th. 8,8 cm - Weight: ± 90 g - P. 133



087188
16 Moulds "Sous-marin" for 8 pieces
15 x 10,5 cm - Th. 10,5 cm - Weight: ± 100 g
P. 131



045565
20 Moulds "Locomotive" for 4 pieces
15 x 12,5 cm - H. 7 cm - Weight: ± 150 g - P. 217



074319
8 Moulds "Voiture Carotte" for 6 pieces
17 x 5,5 cm - Th. 5,7 cm - Weight: ± 80 g - P. 135



074080
16 Moulds "Van" for 6 pieces 19,4 x 7,2 cm
Th. 9 cm - Weight: ± 220 g - P. 217



087189
6 Moulds "Stylo" for 24 pieces 17,7 x 2,4 cm
Th. 2,3 cm - Weight: ± 20 g - P. 216



074117
15 Moulds "Cornets de glace Oh zut" for 5 pieces
Cornet: 5,4 x 11,6 cm - Boule de glace: ø 8,2 cm
H. 4 cm - Weight: ± 60 g - P. 217



074320
12 Moulds "Cagette" for 6 pieces 13,6 x 7,8 cm
Th. 6 cm - Weight: ± 100 g - P. 217



074303
12 Moulds "Bol" for 12 pieces ø 11 cm
Th. 5,6 cm - Weight: ± 80 g - P. 217



074085
12 Moulds "Cloche Ding Dong" for 6 pieces
10,5 x 11 cm - Th. 10,5 cm - Weight: ± 80 g
P. 131

074304
12 Moulds "Couvercle de bol" for 12 pieces
ø 9,7 cm - Th. 0,4 cm - Weight: ± 25 g - P. 217

SILICONE MOULDS FOR DECORATIONS

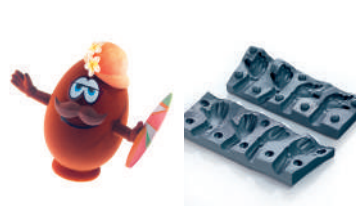

010166
1 Silicone Mould "4 mains avec bras courts"
P. 195



009908
1 Silicone Mould "Les cordelettes" 3 designs
50 cm - P. 195



010225
4 Silicone Moulds "Montre" 4 designs
Dial: ø 16 cm - Great gear: ø 14 cm
Necklace: ø 16 cm - Winder: ø 4,5 cm - P. 195

010226
1 Silicone Mould "Engrenages" 9 designs
9 Gears between ø 2 and ø 4 cm - P. 195

ENTREMETS MOULDS

SILICONE MOULDS



088266
1 Silicone mould "Gobelet" for 6 pieces
ø 6,7 cm - H. 5,6 cm - P. 235



087078
1 Silicone mould "Vrille" for 6 pieces
ø 7 cm - H. 4,5 cm - P. 235



010276
1 Silicone mould "Palet" for 8 pieces
ø 6,5 cm - H. 3 cm - P. 236



088265
1 Silicone mould "Petite tarte" for 6 pieces
ø 7,4 mm - H. 1,17 cm - P. 235



010176
1 Silicone mould "Mini wedding cake"
for 6 pieces ø 7,5 cm - H. 6 cm - P. 236



010274
1 Silicone mould "Ovoïde" for 8 pieces
8,2 x 4,3 cm - H. 3,2 cm - P. 236



088196
1 Silicone mould "Étoile" for 6 pieces ø 7,5 cm
H. 4,5 cm - P. 235

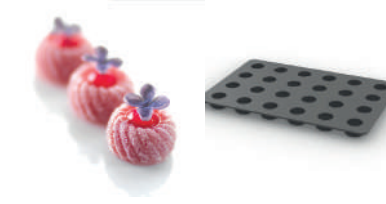

088195
1 Silicone mould "Torsade" for 24 pieces
ø 3 cm - H. 1,7 cm - P. 235



088197
1 Silicone mould "Étoile" for 1 piece ø 19,5 cm
H. 5 cm - P. 237



010051
1 Silicone mould "Bouchon de parfum"
for 1 piece - P. 236



010297
1 Silicone mould "Parfum" for 6 pieces - ø 8 cm
H. 4 cm - P. 236



010119
1 Silicone mould "Mini magnum" for 8 pieces
6,8 x 3,7 cm - Th. 1,8 cm - P. 236



010120
2 Silicone moulds "Magnum" for 12 pieces
9,2 x 4,8 cm - Th. 2,5 cm - P. 236

004668
50 Flat birch sticks 11,2 x 1 cm - P. 236

STRUCTURE SHEETS FOR ENTREMETS

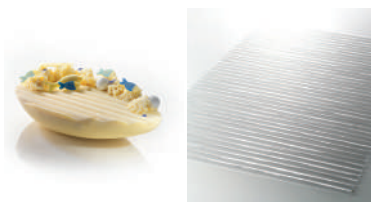

010294
10 Structure sheets "Rondin" 56,5 x 36,5 cm
P. 250

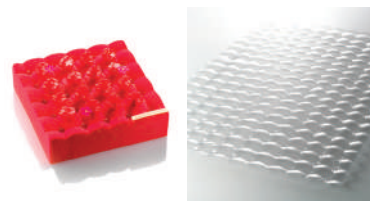

009808
10 Structure sheets "Matelassé" 56,5 x 36,5 cm
P. 250



009836
10 Structure sheets "Mouvance" 56,5 x 36,5 cm
P. 250



060888
10 Structure sheets "Feuillage" 56,5 x 36,5 cm
P. 250



009741
10 Structure sheets "Ondulé" 56,5 x 36,5 cm
P. 250



074351
10 Structure sheets "Écorce" 56,5 x 36,5 cm
P. 250



036161
10 Structure sheets "Déstrucuré" 56,5 x 36,5 cm
P. 250

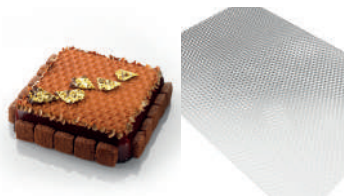

060887
10 Structure sheets "Pyramide" 56,5 x 36,5 cm
P. 250

065067
10 Structure sheets "Écorce" for yule log
52,7 x 17,7 cm - P. 107 and P. 250

060152
10 Structure sheets "Déstrucuré" for yule log
52,7 x 17,7 cm - P. 107 and P. 250

065068
10 Structure sheets "Pyramide" for yule log
52,7 x 17,7 cm - P. 250



060886
10 Structure sheets "Bulles" 56,5 x 36,5 cm
P. 250

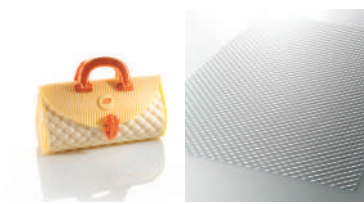

009891
10 Structure sheets "Petit Matelassé"
56,5 x 36,5 cm - P. 251



000368
10 Structure sheets "Ananas" 56,5 x 36,5 cm
P. 251

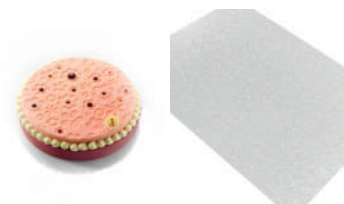

074289
10 Structure sheets "Fleurs" 56,5 x 36,5 cm - P. 251

060155
10 Structure sheets "Bulles" for yule log
52,7 x 17,7 cm - P. 107 and P. 250

060156
10 Structure sheets "Petit Matelassé" for yule log
52,7 x 17,7 cm - P. 107 and P. 251

060154
10 Structure sheets "Ananas" for yule log
52,7 x 17,7 cm - P. 107 and P. 251



060889
10 Structure sheets "Envol" 56,5 x 36,5 cm
P. 251

065066
10 Structure sheets "Envol" for yule log
52,7 x 17,7 cm - P. 107 and P. 251

TEARABLE MOULDS

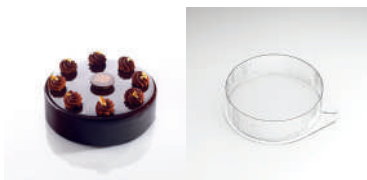

070552
100 Entremets moulds "Rond plat" for 100 pieces
ø 14 cm - H. 4 cm Tearable moulds - P. 239

070553
100 Entremets moulds "Rond plat" for 100 pieces
ø 16 cm - H. 4 cm Tearable moulds - P. 239

070554
100 Entremets moulds "Rond plat" for 100 pieces
ø 18 cm - H. 4 cm Tearable moulds - P. 239

070555
100 Entremets moulds "Rond plat" for 100 pieces
ø 20 cm - H. 4 cm Tearable moulds - P. 239



070556
100 Entremets moulds "Rond plat" for 100 pieces
ø 14 cm - H. 4,5 cm Tearable moulds - P. 239

070557
100 Entremets moulds "Rond plat" for 100 pieces
ø 16 cm - H. 4,5 cm Tearable moulds - P. 239

070558
100 Entremets moulds "Rond plat" for 100 pieces
ø 18 cm - H. 4,5 cm Tearable moulds - P. 239

070559
100 Entremets moulds "Rond plat" for 100 pieces
ø 20 cm - H. 4,5 cm Tearable moulds - P. 239

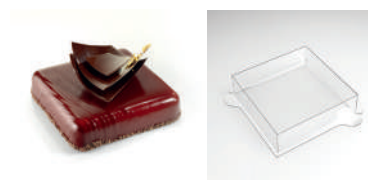

070564
100 Entremets moulds "Carré plat arrondi"
for 100 pieces 14 x 14 cm - H. 4 cm Tearable moulds
P. 239

070565
100 Entremets moulds "Carré plat arrondi"
for 100 pieces 16 x 16 cm - H. 4 cm Tearable moulds
P. 239

070566
100 Entremets moulds "Carré plat arrondi"
for 100 pieces 18 x 18 cm - H. 4 cm Tearable moulds
P. 239



074074
30 Entremets moulds "Œuf 4 personnes" for 30
pieces 12 x 19 cm - H. 4 cm Tearable moulds
P. 241

074075
30 Entremets moulds "Œuf 6 personnes" for 30
pieces 16,2 x 24 cm - H. 4 cm Tearable moulds
P. 241



087009
100 Entremets moulds "Rond plat arrondi"
for 100 pieces ø 14 cm - H. 3 cm Tearable moulds
P. 240

087011
100 Entremets moulds "Rond plat arrondi"
for 100 pieces ø 16 cm - H. 3 cm Tearable moulds
P. 240

087013
100 Entremets moulds "Rond plat arrondi"
for 100 pieces ø 18 cm - H. 3 cm Tearable moulds
P. 240

087018
100 Entremets moulds "Rond plat arrondi"
for 100 pieces ø 20 cm - H. 3 cm Tearable moulds
P. 240



087010
100 Entremets moulds "Rond plat arrondi"
for 100 pieces ø 14 cm - H. 3,5 cm Tearable moulds
P. 240

087012
100 Entremets moulds "Rond plat arrondi"
for 100 pieces ø 16 cm - H. 3,5 cm Tearable moulds
P. 240

087014
100 Entremets moulds "Rond plat arrondi"
for 100 pieces ø 18 cm - H. 3,5 cm Tearable moulds
P. 240

087019
100 Entremets moulds "Rond plat arrondi"
for 100 pieces ø 20 cm - H. 3,5 cm Tearable moulds
P. 240



070560
100 Entremets moulds "Rond plat arrondi"
for 100 pieces ø 14 cm - H. 4 cm Tearable moulds
P. 240

070561
100 Entremets moulds "Rond plat arrondi"
for 100 pieces ø 16 cm - H. 4 cm Tearable moulds
P. 240

070562
100 Entremets moulds "Rond plat arrondi"
for 100 pieces ø 18 cm - H. 4 cm Tearable moulds
P. 240

070563
100 Entremets moulds "Rond plat arrondi"
for 100 pieces ø 20 cm - H. 4 cm Tearable moulds
P. 240



070567
30 Entremets moulds "Dessus de tarte"
for 30 pieces ø 15 cm H. 1,8 cm Tearable moulds
P. 241

070568
30 Entremets moulds "Dessus de tarte"
for 30 pieces ø 17 cm H. 1,8 cm Tearable moulds
P. 241

087075
30 Entremets moulds "Dessus de tarte"
for 30 pieces ø 18 cm H. 2 cm Tearable moulds
P. 241

070569
30 Entremets moulds "Dessus de tarte"
for 30 pieces ø 19 cm H. 1,8 cm Tearable moulds
P. 241



070514
30 Entremets moulds "Lettre" for 30 pieces
20,5 x 14 cm - H. 3,5 cm Tearable moulds - P. 241



060224
10 Entremets moulds "Spirale" for 10 pieces
ø 18 cm - H. 1,5 cm Tearable moulds - P. 241

INDIVIDUALS ENTREMETS MOULDS



087015

22 Entremets moulds "Sapin" for 36 pieces - Top: 8,75 x 11,2 cm - H. 2,4 cm - Moulds with support jambs - Bottom: 8,97 x 11,4 cm - H. 0,5 cm Moulds without support jambs - P. 96



070527

30 Entremets moulds "Igloo" for 120 pieces 8 x 8,6 cm - H. 3,7 cm - Moulds with support jambs P. 97



070525

30 Entremets moulds "Bonnet de Père Noël" for 120 pieces ø 7 cm - H. 5,2 cm - Moulds with support jambs - P. 97



070545

30 Entremets moulds "Champagne" for 90 pieces 5,8 cm x 13,5 cm - H. 3 cm - Moulds with support jambs - P. 97



074233

30 Entremets moulds "Étoile" for 180 pieces 8 x 7,6 cm - H. 4 cm Moulds with support jambs P. 97

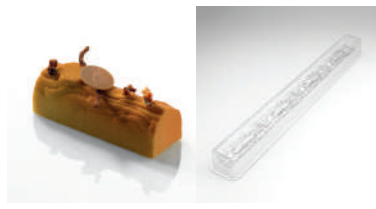

070575

10 Entremets moulds "Bûchette rondin" 54 x 3,8 cm H. 3,8 cm - Moulds with support jambs - P. 97

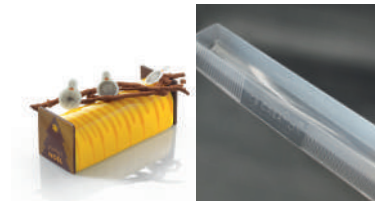

045841

10 Entremets moulds "Mini-bûchette" 54 cm x 3,8 cm H. 3,8 cm - P. 97



070511

30 Entremets moulds "Souche" for 120 pieces ø 7 cm - H. 3,5 cm - Moulds with support jambs P. 30



070529

30 Entremets moulds "Citrouille" for 120 pieces ø 7,5 cm - H. 1,8 cm - Moulds with support jambs P. 30



074234

30 Entremets moulds "Citrouille" for 120 pieces 8,5 x 8,9 cm - H. 3,3 cm - Moulds with support jambs - P. 30



010354

1 Tray for entremets individual "Ronds" for 45 pieces ø 6 cm - H. 4 cm - P. 243

005000

200 Rhodoïde sheets neutral 19,5 x 4 cm



070551

30 Entremets moulds "Dôme" for 120 pieces ø 6,8 cm - H. 4 cm - Moulds with support jambs P. 243



070546

30 Entremets moulds "Charlotte" for 120 pieces 8 x 8,3 cm - H. 3,2 cm - Moulds with support jambs P. 242



070550

30 Entremets moulds "French Donut" for 150 pieces ø 8 cm - H. 1,9 cm - Moulds with support jambs P. 243

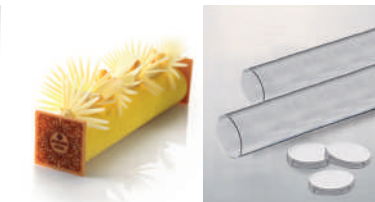

009790

10 "Molines" tubes 58 cm ø 3,5 cm and 20 covers 100 Rhodoïde sheets neutral 58 x 12 cm - P. 243

005002

100 Rhodoïde sheets neutral 58 x 12 cm



010241

4 Entremets moulds "Tong" for 48 pieces 12,5 x 5,7 cm H. 1 cm - P. 243

010242

1 Cookie cutter "Tong" 12,9 x 6,1 cm - P. 243

001667

4 Blisters "Lanière de tong" so 48 prints - 5,1 x 5,3 cm P. 243

004435

100 Small cardboard "Tong" P. 243



009941
10 Entremets tubes "sucettes" - ø 3,5 cm - H. 8 cm
P. 243

005013
200 Rhodoïde sheets neutral 12 x 8 cm

004568
200 Flat beech sticks 9,3 x 1,8 cm



074245
30 Entremets moulds "Œuf bombé" for 120 pieces
6 x 10 cm - H. 3 cm - Moulds with support jambs
P. 141



074064
30 Entremets moulds "Lapinou"
for 120 pieces 10 x 8 cm - H. 4 cm
Moulds with support jambs - P. 141



070515
30 Entremets moulds "Cœur spirale" for 120 pieces
8,4 x 8 cm - H. 3,3 cm - Moulds with support jambs
P. 115



070548
30 Entremets moulds "Pomme" for 60 pieces
Top ø 7,4 cm - H. 2,6 cm - Moulds with support
jambs - Bottom ø 7,4 cm - H. 3,7 cm - Moulds with
support jambs - P. 115



074062
30 Entremets moulds "Double cœur" for 240 pieces
(so 120 entremets) 5 x 8,7 cm 5,4 x 9,4 cm
H. 4,5 cm - Moulds with support jambs - P. 115



074063
30 Entremets moulds "Cœur drapé"
for 120 pieces 8,5 x 7,5 cm - H. 3,8 cm
Moulds with support jambs - P. 115



074061
30 Entremets moulds "Bouche" for 180 pieces
9,5 x 5,6 cm - H. 3,5 cm - Moulds with support
jambs - P. 115



074060
30 Individual entremets moulds "Petite tarte rose"
for 120 pieces ø 7,4 cm - H. 2 cm - P. 115 and P. 245



074059
30 Individual entremets moulds "Petite tarte fleur"
for 120 pieces ø 7,4 cm - H. 1,7 cm
Moulds with support jambs - P. 245



070534
30 Individual entremets moulds "Petite tarte
meringuée" for 120 pieces ø 7,4 cm - H. 2,7 cm
Moulds with support jambs - P. 245



070520
30 Individual entremets moulds "Petite tarte"
for 120 pieces ø 7,4 cm - H. 1,7 cm - Moulds with support
jambs - P. 245



070535
30 Individual entremets moulds "Petite tarte
pochage" for 120 pieces ø 7,4 cm - H. 2,3 cm -
Moulds with support jambs - P. 245

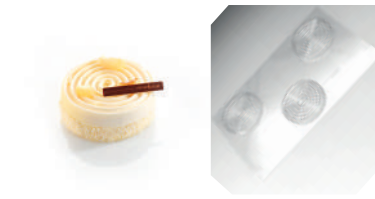

060221
16 Individual entremets moulds "Spirale" for
48 pieces ø 8 cm - H. 1,5 cm - P. 245



070536
30 Individual entremets moulds
"Palet" for 150 pieces ø 8 cm
H. 1,7 cm - Moulds with support
jambs - P. 115 and P. 245

ENTREMETS MOULDS



087016
45 Entremets moulds "Sapin" for 30 pieces - Top: 17,7 x 22,6 cm - H. 4,5 cm - Moulds with support jamba - Bottom: 18,2 x 23,2 cm - H. 0,5 cm Moulds without support jamba - P. 99

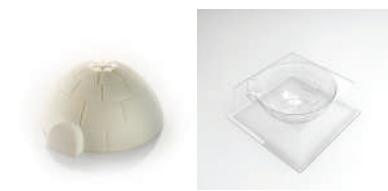

070528
30 Entremets moulds "Igloo" for 30 pieces 19,5 x 21 cm - H. 9 cm - Moulds with support jamba P. 99



070524
30 Entremets moulds "Bonnet de Noël" for 30 pieces ø 18 cm - H. 15 cm - P. 99



074235
30 Moulds Entremets "Étoile" for 30 pieces 21 x 22 cm - H. 5,5 cm - Moulds with support jamba - P. 99



065313
10 Entremets moulds "Sphère" to clip for 5 pieces ø 12 cm H. 10 cm - Moulds with support jamba - P. 99

065122
2 Blisters "Attache-boules" so 80 prints ø 3 cm - H. 0,8 cm - P. 99



088191
60 Entremets moulds "Couronne" for 30 pieces Top: ø 21,9 cm - H. 2,3 cm Bottom: ø 22,3 cm - H. 0,8 cm - P. 99



065150
5 Structure sheets pre-folded "Bois" for cube 10 cm - P. 30

009952
1 Mould "Cube" for 5 pieces 10 x 10 cm - H. 10 cm - P. 30

005018
100 Rhodoïde sheets neutral 10 x 10 cm - P. 30

009910
1 Inox mould Cube 10 x 10 cm - H. 10 cm - P. 30



088248
30 Entremets moulds "Oursin" for 30 pieces 13,1 x 22,3 cm - H. 6,65 cm - Moulds with support jamba - P. 98



070517
30 Entremets moulds "Souche" for 30 pieces ø 18 cm H. 4 cm - Moulds with support jamba P. 30 and P. 247



070530
30 Entremets moulds "Citrouille" for 30 pieces ø 16 cm - H. 4,4 cm - Moulds with support jamba P. 30



074243
30 Entremets moulds "Citrouille" for 30 pieces 15,8 x 16,5 cm - H. 4,7 cm - Moulds with support jamba - P. 31



087061
60 Entremets moulds "Panama" for 30 pieces Top: 12,7 x 15 cm - H. 7 cm - Moulds with support jamba - Bottom: 21 x 21 cm - H. 1,3 cm - Moulds with support jamba - P. 247

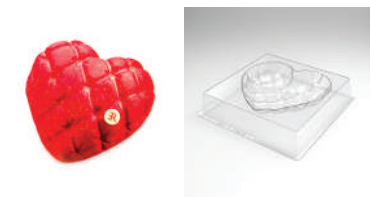

070516
30 Entremets moulds "Cœur matelassé" for 30 pieces 14,5 x 14,5 cm - H. 3,5 cm Moulds with support jamba - P. 114

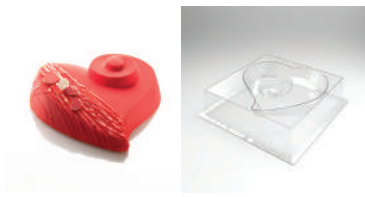

070512
30 Entremets moulds "Cœur spirale" for 30 pieces 17,3 x 17,8 cm - H. 5 cm - Moulds with support jamba - P. 114

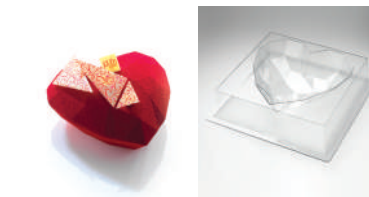

074070
30 Entremets moulds "Cœur diamant" for 30 pieces 14,5 x 14,5 cm - H. 4 cm - Moulds with support jamba - P. 114



074067
30 Entremets moulds
"Bouche" for 30 pieces
for 20 x 12 cm - H. 5 cm
Moulds with support
jambes - P. 114



074069
30 Entremets moulds
"Bouche pour 2" for
60 pieces 14,3 x 8,3 cm
H. 4 cm - Moulds with
support jambes - P. 114



074066
30 Entremets moulds "Cœur drapé"
for 30 pieces 15,1 x 13,3 cm - H. 6,4 cm
Moulds with support jambes - P. 114

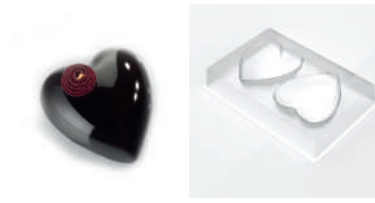

087017
30 Entremets moulds "Cœur" for 60 pieces
11,2 x 11,8 cm - H. 3,8 cm - Moulds with support
jambes - P. 114



074068
30 Entremets moulds "Nid" for 30 pieces ø 14 cm
H. 2 cm - Moulds with support jambes - P. 141



070518
30 Moulds entremets "Demi-sphère" for 30 pieces
ø 14 cm - H. 7 cm - Moulds with support jambes
P. 249



070541
30 Moulds "Rose" (top) for 30 pieces ø 15 cm
H. 1,2 cm - Moulds with support jambes - P. 249

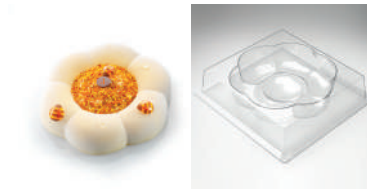

074071
30 Entremets moulds "Fleur" for 30 pieces
16 x 17 cm - H. 4 cm - Moulds with support jambes
P. 249



070537
30 Entremets moulds "Rosace" for 30 pieces ø 15 cm
H. 1,5 cm - Moulds with support jambes - P. 249

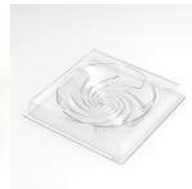

070522
30 Entremets moulds "Demi-sphère" for 30 pieces
ø 18 cm - H. 9 cm - Moulds with support jambes
P. 249



088188
30 Entremets moulds "Noisette 4 personnes"
for 30 pieces 14 x 14,5 cm - H. 4 cm
Moulds with support jambes - P. 246



088189
30 Entremets moulds "Noisette 6 personnes"
for 30 pieces 17 x 18 cm - H. 4 cm
Moulds with support jambes - P. 246



060881
2 Rectangle Moulds "Cake" for 1 piece
25 x 7 cm - H. 7 cm - P. 249

060880
100 Transfer sheets "Marbre noir" for 20 cakes
6,9 x 6,9 cm - 6,9 x 25 cm - P. 249



070521
30 Entremets moulds "Vrille" for 30 pieces
ø 17 cm - H. 9,5 cm - Moulds with support jambes
P. 249

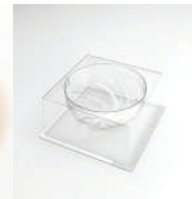

070542
30 Entremets moulds "Vrille" for 30 pieces
ø 14 cm - H. 7 cm - Moulds with support jambes
P. 249



074246
30 Entremets moulds "Œuf bombé" for 30 pieces
16 x 26 cm - H. 5 cm - Moulds with support jambes
P. 141

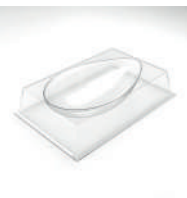

074065
30 Entremets moulds "Lapin" for 30 pieces
14,4 x 17,8 cm - H. 7 cm Moulds with support jambes
P. 141

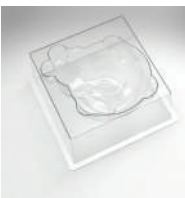

070513
30 Entremets moulds "St Honoré" for 30 pieces
ø 16 cm - H. 6 cm - P. 247



074236
30 Entremets moulds "Candy" for 30 pieces
ø 17 cm - H. 4 cm - Moulds with support jambes
P. 247



MOULDS “CADRES PÂTISSIERS”



074072
10 Entremets moulds “Cadre Pâtissier” for
10 pieces 57 x 37 cm - H. 3,5 cm - P. 248



070584
10 Entremets moulds “Cadre Pâtissier” for
10 pieces 57 x 37 cm - H. 4 cm - P. 248



074073
10 Entremets moulds “Cadre Pâtissier” for
10 pieces 57 x 37 cm - H. 4,5 cm - P. 248

YULE LOG MOULDS



070587
10 Yule log moulds “Standard” 54 x 8 cm
H. 6,5 cm - P. 105



060234
10 Moulds “Petite bûche gouttière” 54 x 5,7 cm
H. 5 cm - P. 105



045841
10 Moulds “Mini-bûchette” 54 x 3,8 cm - P. 105

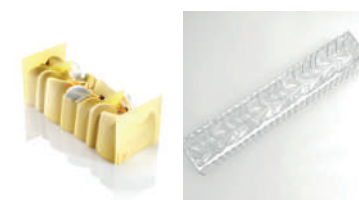

065147
10 Yule log moulds “Ooreka” 54 x 8 cm
H. 6,5 cm - Moulds with support jambs - P. 102

048001
100 Rhodoïde sheets neutral 52,7 x 17,7 cm
to insert into the mould 070587 - P. 105

060235
100 Rhodoïde sheets neutral 52,7 x 12,7 cm
to insert into the mould 060234 - P. 105

048002
100 Rhodoïde sheets neutral 52,7 x 9,5 cm
to insert into the mould 045841 - P. 105

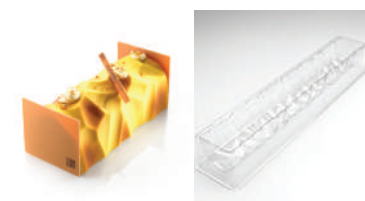

070573
10 Yule log moulds “Facettes” 54 x 8 cm
H. 6,5 cm - Moulds with support jambs - P. 103



070574
10 Yule log moulds “Fond plat” 54 x 8 cm
H. 6,5 cm - Moulds with support jambs - P. 103



000366
4 Yule log moulds “Boules” 51 x 8 cm
H. 6,5 cm - Moulds with support jambs - P. 103

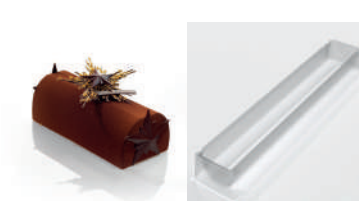

087068
10 Yule log moulds “Dessus plat” 54 x 8 cm
H. 6,5 cm - Moulds with support jambs - P. 100

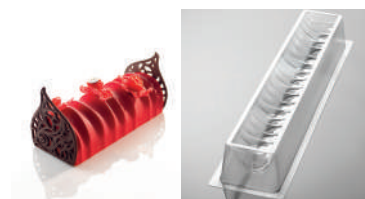

060233
10 Yule log moulds “Ondes” 54 x 8 cm
H. 6,5 cm - Moulds with support jambs - P. 103



060232
10 Yule log moulds “Montagne” 54 x 7 cm
H. 8 cm - Moulds with support jambs - P. 103

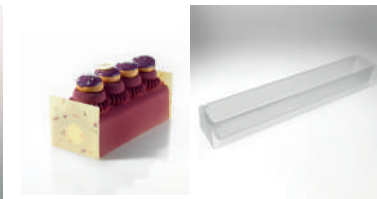

074244
10 Yule log moulds “Rectangle arrondi” 54 x 8 cm
H. 6,5 cm - Moulds with support jambs - P. 102



009992
1 Yule log mould “Tube” 50 cm ø 6,4 cm
and 2 covers - P. 104

005019
100 Rhodoïde sheets neutral 50 x 21 cm - P. 104

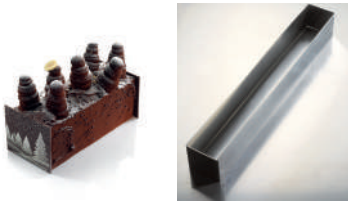

009922

1 Inox Mould "Bûche carrée" 50 x 7 cm
H. 7 cm - P. 103

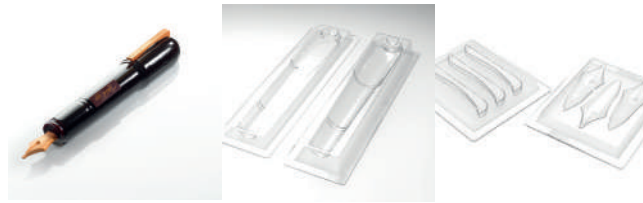

074241

30 Yule log moulds "Stylo" for 15 pieces 37,8 x 7,1 cm H. 6 cm - Moulds with support jambs - P. 102

074242

10 Moulds "Accessoires Bûche Stylo" for 30 pieces 12 x 3,8 cm - 13,5 x 2,3 cm - H. 1 cm
Moulds with support jambs - P. 102

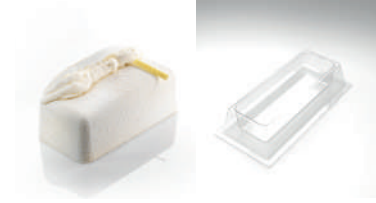

074237

30 Entremets moulds "Lingot 24 cm" for 30 pieces
24 x 8 cm - H. 5,5 cm - Moulds with support jambs
P. 102

074238

30 Entremets moulds "Lingot 16 cm" for 30 pieces
16 x 8 cm - H. 5,5 cm - Moulds with support jambs
P. 102



070526

30 Yule log moulds "Champagne" for 30 pieces
25 x 9 cm - H. 5,6 cm - Moulds with support jambs
P. 104

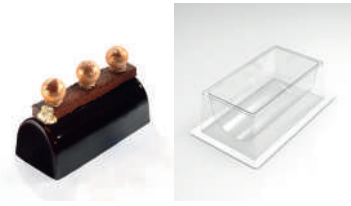

074239

30 Yule log moulds "6 parts" for 30 pieces
18 x 8 cm - H. 6,5 cm - Moulds with support jambs
P. 104



070519

30 Yule log moulds "Trésor" for 30 pieces 20 x 8 cm
H. 7,2 cm - Moulds with support jambs - P. 104

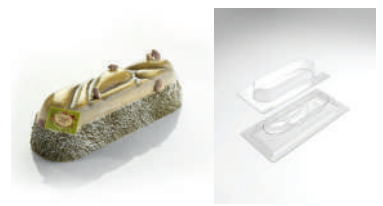

070571

30 Moulds "Bûche Mont blanc" for 15 pieces:
Top: 22,8 x 6 cm - H. 2,8 cm Moulds with support
jambs - Bottom: 25 x 8 cm H. 4,5 cm - P. 104



070544

30 Yule log moulds "Nuage" for 30 pieces 20 x 11 cm
H. 7 cm - Moulds with support jambs - P. 104



074240

30 Yule log moulds "Arrondie" for 30 pieces
20 x 8 cm - H. 7 cm - Moulds with support jambs
P. 102

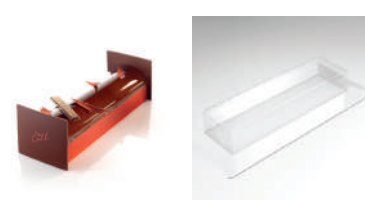

070538

30 Yule log moulds "Dessous de bûches" for 30
pieces 24 x 7 cm - H. 4 cm - P. 101



070539

30 Yule log moulds "Rondin" for 30 pieces
23,6 x 6,6 cm - H. 3,5 cm - Moulds with support
jambs - P. 101



070532

30 Yule log moulds "Marquise" for 30 pieces
23,6 x 6,6 cm - H. 2 cm - Moulds with support
jambs - P. 101

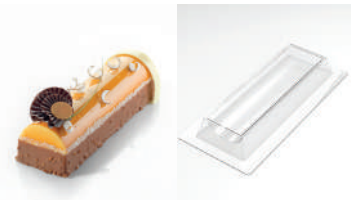

070533

30 Yule log moulds "Duchesse" for 30 pieces
23,6 x 6,6 cm - H. 3 cm - Moulds with support
jambs - P. 101



070540

30 Yule log moulds "Éminence" for 30 pieces
23,6 x 6,6 cm - H. 2,5 cm - Moulds with support
jambs - P. 101





Keep in touch

WITH THE MANUFACTURE OF EMOTIONS



ORDER 24 HOURS A DAY ON OUR WEBSHOP
www.pcb-creation.fr



PCB CREATION

Manufacture d'émotions

1 RUE DE HOLLANDE • CS 60067 • 67232 BENFELD CEDEX • FRANCE

Tel. 33 (0)3 88 587 333 • Fax. 33 (0)3 88 587 334

Export Dpt: 33 (0)3 88 587 336 • Accounting Dpt: 33 (0)3 88 587 338

pcb.creation@pcb-creation.fr • www.pcb-creation.com



(01)0361466085523(115)340401(10)1303230004

PCB STUDIO - Photographie : Studio Pygmalion - FÉVRIER 2024 - RC STRASBOURG 2005B138 - Photos non contractuelles